

Thermoscreens Fan Coil Unit

INSTALLATION, OPERATING AND MAINTENANCE INSTRUCTIONS



1 CONTENTS

Introduction.....	Error! Bookmark not defined.
Safety	3
Storage.....	4
Transport.....	4
Installation	4
Unit Positioning And Accessibility.....	4
Installing The Unit	5
Connecting Ductwork.....	6
Connecting the Electrical Supply.....	7
Connecting the Controls Cabling.....	8
Commissioning and Setting to Work	9
Initial Startup.....	9
Service and Maintenance.	10
Warranty and Repairs.....	10
Recycling and Disposal.	10
Maintenance & Procedures.....	10
Filters	10
Fan Replacement.....	11
Condensate Drain Trays	11
Coil Maintenance and Removal.....	12
Maintenance Schedule.....	13
Spare Parts.....	14

1. INTRODUCTION

This Installation, Operation and Maintenance manual relates to the Thermoscreens Horizontal Fan Coil Units (FCU) designed and manufactured by Thermoscreens to provide cooling and heating to internal spaces.



The information contained in this document provides guidance on how this product is installed, operated and maintained. It is to be handed over to the end user to ensure the product is maintained over its working life.

You should refer to project specific documentation for performance information that is project related.

2. SAFETY

These product instructions detail the installation, operation and maintenance, of the Thermoscreens fan coil units. Such actions can have impact on safety. Where hazards have been identified the symbols below will be shown. Should any part of these instructions become damaged, unreadable or a copy is needed, they can be downloaded from the Thermoscreens website listed on page 2.

Before carrying out any maintenance to the unit, the user should ensure the unit has been electrically isolated from supplies, isolated from any pipework connections and the unit left to cool down sufficiently. Fan coils are installed as part of a system with boilers, chillers and electrical supplies that means when carrying out work on any part of this system, the worker should ensure that the whole system is considered and not solely the equipment being worked on.

	Electrical Hazard		Hot Surfaces Hazard
	General Warning		

The installer is responsible for ensuring:

- The equipment has been installed in a safe and suitable manner with consideration for the immediate environment and ongoing maintenance that will be required to maximize the working life of the unit.
- That the installation is in-line with the manufacturer’s instructions and consideration of industry best practice and in agreement with all applicable statutory legislation and regulations.
- The work is carried out by competent workers who have fully read and understand these instructions, the scope of work and who have the required tools, equipment and personal protective equipment to minimize risks.

This product must not be installed, used or maintained by children, persons with reduced physical, sensory or mental capabilities or persons who lack of experience and knowledge concerning use of the product in a safe way and the hazards involved.

3. STORAGE

The product must be stored in a dark, dry, frost-free and well ventilated place out of the reach of children. Storage temperatures should be between 0-30°C. The original packaging should be used for long-term storage.

4. TRANSPORT

Prior to transporting the product, it should be removed and stowed safely so as to not incur damage. The original packaging should be used wherever possible and the product should be protected from any significant temperatures or vibration.

5. INSTALLATION

Unit Positioning and Accessibility



Caution – Some parts of this product can become very hot and cause burns. Particular attention has to be given where children and vulnerable people are present.

The units are intended to be installed more than 1.8m above the floor level, above a suspended ceiling or at high level where there is no ceiling, exposed to view.

The product is only for indoor use where dry conditions can be guaranteed, in an ambient temperature range of 10°C – 40°C.

Qualified and professional personnel should be used in all instances to determine exact methods of working using these instructions as a guide to good practice.



It is the installer's responsibility to ensure that the operational and environmental limitations of the equipment meet the project requirements.

The installer should choose a suitable place to install the unit, noting clearance requirements for servicing and maintenance as detailed below:

Fans – An access panel is located at the bottom of the unit. This is the full width of the unit. 270mm (Thermoscreens Fan Coil 270) beneath the units and clear access.

Inlet Air Filter – Access to the inlet air filter is from the bottom and out the back inlet of the unit. 270mm (Thermoscreens Fan Coil 270) under the unit with clear access, plus a minimum of 200mm at the rear inlet of the unit.

Water and Drainage – These are dependent on the specific handling of the unit, as defined during the manufacturing of the order. Should the handling be unsuitable for connection, please contact our sales office to discuss further.

Electrical Connection – From left or right-hand side to suit handing (see 'Water and Drainage' above).

Drain Tray Removal – Access from the underside of the unit. The drain tray is held in place by 4 retaining screws, 2 on each side of the unit.

Heat Exchanger (coil) removal – Accessed from the underside of the unit with fixing points on both sides.

Control/Electrical Enclosure – From left or right hand of the unit. 270mm (Thermoscreens Fan coil 270) from underside and 500mm from the vertical cover.

Valves – The unit is typically supplied with either project-specific (free issued) valves, or Thermoscreens standard 4 port offer. The customer is to ensure that isolation valves are placed suitably close to the unit to allow for disconnection during future servicing and maintenance.

Data Label - Each unit is supplied with a serial number marked on the data label on the underside of the unit - this should be visible once installed to allow for accurate unit identification.



Failure to provide adequate access will prevent adequate servicing and maintenance of the unit that can negatively impact the life expectancy of the unit and any warranty.

Installing the Fan Coil Unit

None of the connection points, spigots/drain connection/coil connections/controls enclosure, are designed to be load bearing or support external equipment during installation or thereafter.

The unit must be installed horizontal and level across both its width and length, however a slight incline of 2 or 3 degrees towards the condensate drain point is acceptable.

Each unit is provided with four fixed hanging points. These are designed for a M10 fixing or drop rod supports to take the full weight of the unit. Mechanical fixings must be used to fix the appliance - adhesives are not deemed suitable.



In normal operation the unit will not exhibit a significant level of vibration, however vibration mitigation treatment may be necessary in certain situations. Where units are installed with vibration limiting equipment, flexible connections should be applied to all other services connected.

Installing Inlet Extension (Optional)

The units are available with a separate inlet extension that's fitted to the unit once installed. Secure the extension onto the front of the unit, fixing it securely with the three fixings on either side circled below and the drop rod fixings. Remove the filter from the unit and reposition it to the front of the inlet extension.

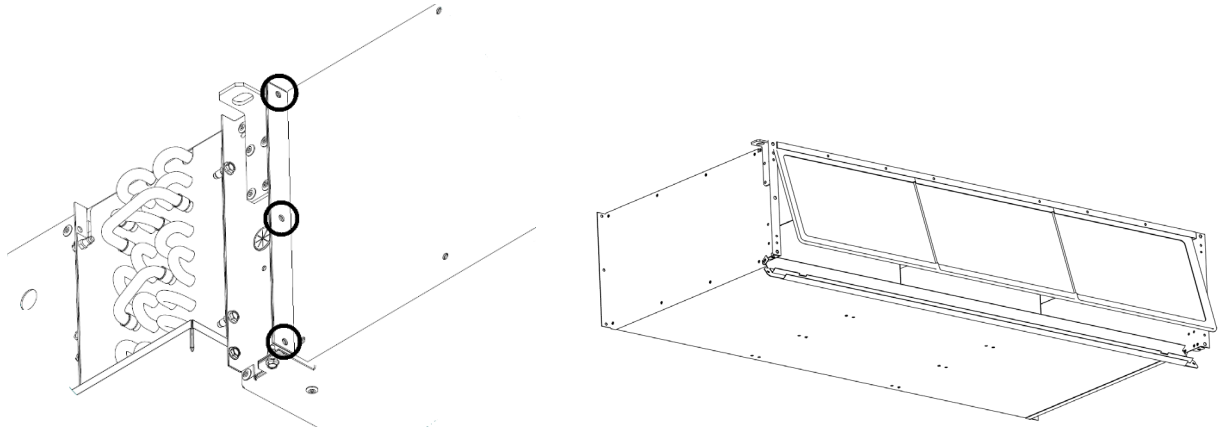

Connecting Ductwork

Standard ductwork connections to units are circular or angular slip joints and must be independently supported to not impose any load/weight on the unit spigot connections. The installer is responsible for sealing the ductwork connections to the unit to ensure air tightness requirements are met.

Flexible ductwork is sometimes used to connect the unit to the grille plenums. The amount of flexible ductwork should be limited to the final 1m to allow for small alignment issues between the solid ductwork and the plenum connection. Acoustic flexible ductwork should be used to ensure final noise levels meet with levels specified for the project.

All ductwork is to be sized by the installer to suit the product performance. Overly small ductwork can cause increased pressure drop, resulting in increased noise levels and fan wear.

Connecting the drain tray

During normal operation condensation may occur that will need to be moved away from the unit. This is captured by the drain tray for collection and removal.

Standard connection to the drain tray is 15mm copper tube and this should be connected to a suitable drainage system.

Condensate pumps can be fitted to the unit to provide an initial lift to a gravity drain system. The pump contains an alarm function that can signal either pump failure, or that excessive condensation is being produced. When the unit is purchased with Thermoscreens standard controls, this alarm will be interlocked with the cooling actuator such that cooling will be disabled until the condensate is removed.

Connecting hot and cold water services

The unit incorporates a water to air heat exchanger with provision to connect to both cooling and hot water services.

All connections on the heat exchanger are 15mm copper plain ends at 40mm centres in the horizontal plane. The connections are identified by a label indicating supply and return connections on the side of the unit requested by the customer. The coil is designed as counterflow operation and is used to maximise thermal performance whilst minimising energy consumption.

The coil connections must be damage free before installing the unit, and care must be taken not to create any undue stress which may cause a fracture to the copper tails. If specified at time of order, the unit will come with a factory fitted valve set. For connection to these please refer to the project specific documentation sent with the product.

Coils must be protected from extreme temperatures that would result in freezing and damage to the copper pipes.

The maximum operating pressure of the coil is 16 Bar (1600kPa).



It is the installer's responsibility to check and ensure that any water treatment required is in place and meets with the requirement of the project.



It is the installer's responsibility to ensure all relevant industry standards and codes of practice are followed and must conform to all statutory legislation or regulations that are applicable.

Connecting the Electrical Supply

The electrical installation must conform to all relevant Standards.

The equipment is intended to be connected to a 230 VAC 50 Hz, electrical supply.

The power supply must be via a single phase local isolator (customer supplied) with a contact separation on both Live and Neutral poles of at least 3mm. Please note the isolator must be fitted within an accessible position and labelled accordingly.

The unit can be supplied with a UK 3 pin plug and 1m flex lead if specified at time of order. It is the installer's responsibility to ensure correct connection of the mains wires and installation of the cable gland (supplied) to secure the cable.

Alternatively, the equipment is provided with a loose cable gland for connection via a suitable 3 core cable from the local fused spur. If the supply cord is damaged it must be replaced by the manufacturer, it's service agent or similarly qualified person in order to avoid a hazard.

Access to the connection electrical block is via removing the Controls Enclosure cover.

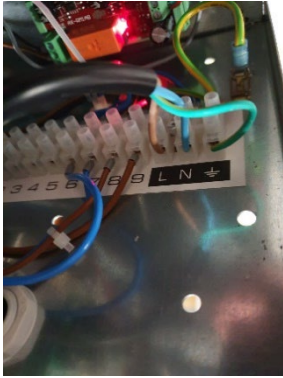

The connection block is clearly labelled with L (Live), N (Neutral) and \perp (Earth).

Once installed, care must be taken to ensure that the fixed wiring insulation is protected from hot surfaces by either positioning it away from the surfaces, or using insulating sleeving with an appropriate temperature rating.

Connecting the Controls Cabling

The unit's controls cables, sensor leads and BMS communication cable should not be routed alongside or in the same cable tray as the mains 230 Volt power. A separation gap, in line with current industry best practice, should be maintained to ensure any interference is kept to a minimum.

The product is available with multiple options for controls:

- No controls – the unit is supplied for the installer to supply and fit their own controls.
- Project specific controls (free issued) – for information on how to use the product, the installer should refer to the project specific wiring guides and controller data sheets to ensure correct connection and operation of the unit.
- Thermoscreens specified controls – a digital controller is supplied and fitted to control the temperature and fan speeds with optional wall controllers.

The remainder of this section is related wholly to the Thermoscreens Specified Controls.

6. CONTROLS

If specified at time of order, the product will be delivered with a factory fitted Johnson Controls TUC03 to allow the unit to operate in the following ways:

- Standalone
- Standalone with a room controller
- Master/Slave with other Thermoscreens units
- From a Building Management Systems (BMS) with Bacnet MS/TP interface

Standalone

The TUC03 is a configurable direct digital controller (DDC) that will control the fan speed and valve actuators based on sensors fitted within the product to effectively manage the space temperature. By default, the product will operate from a fixed set-point of 22°C. For optimal user comfort and control we recommend that a room controller (detailed below) is fitted.

Standalone with Room Control Module (RCM)

The product is supplied as above but with a room control module allowing users to adjust the temperature and fan speeds of the product. Each wall controller is supplied with a separate user manual about how to fit, wire and control the unit with it.

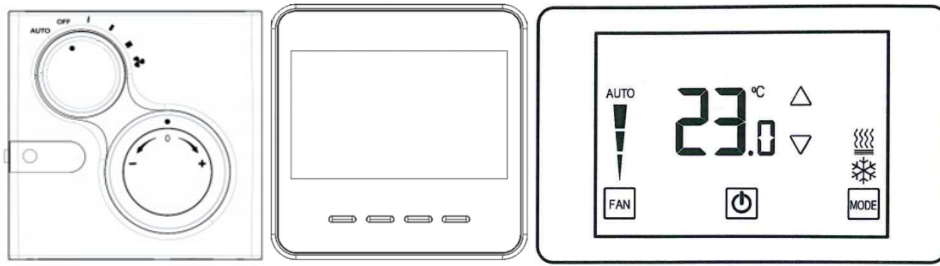

The RCM should be fixed to a wall near to the product within the space that the unit is heating/cooling, away from any cold draughts or radiative heat sources. Wiring to the product should be done with twisted cable with a length of less than 25m.

Master/Slave with other Thermoscreens units

The TUC03 will allow multiple similar products to be connected together to ensure they all heat/cool collectively. Where multiple units are used in the same space, Thermoscreens recommend that this function is enabled to avoid each unit competing against each other causing substantial increase in running costs. For users who wish to use this feature please ask our sales team for wiring diagram ENG001 that details the wiring and DIP switch settings needed.

From a Building Management Systems (BMS) with Bacnet MS/TP interface

The TUC03 contains a Bacnet MS/TP interface that will allow full and advanced control of the product from external devices over the network. These options are only available for advanced users and will alter the functionality of the product. Any changes of the controller's internal values will invalidate any warranty concerning the product's controls and should only be attempted by competent users.

7. COMMISSIONING

With the unit isolated, the following should be checked:-

- Check filter is clean and free from dust
- Check coil is clean and free from obstructions
- Hand spin fans to ensure no damage has occurred during transportation and installation
- Check all water connections for leaks
- Vent the coil to ensure that any trapped air is vented
- Put a small amount of water into the condensate tray to prime the system
- Check that all access panels are in place
- Check that the controls enclosure cover is fitted
- Check operational isolators and controls
- Check that all secondary ductwork balancing dampers are fully open

The unit must not be put into operation until any issues found are resolved.

Initial Startup

After the initial commissioning and setting to works checks, the unit may be started.

- Connect/Switch on the power supply.
- Check that the correct speed control signal is being applied by the local controller and/or potentiometer.
- Run the fans for at least 10 minutes.
- If required, proportionally balance the FCU secondary air volumes.
- Adjust the fan speed control voltage so that the unit delivers the design air volume.

8. SERVICE & MAINTENANCE

Always disconnect and isolate the mains electricity supply before installing, maintaining or repairing this equipment. All maintenance/repairs should only be carried out by a competent electrician or Thermoscreens appointed technician. To ensure the Fan Coil Unit operates efficiently the air inlet filter and outlet grilles, fan impellers, housings and motors must be kept free of dust and debris. Regularly vacuum and clean any build-up of dirt and debris within the unit (please note that the motor is permanently lubricated and requires no additional lubrication). Once the unit has been cleaned check all electrical connections within the unit, ensuring terminals are tight and that crimped connections have not become loose.

9. WARRANTY & REPAIRS

If any problems are encountered, please contact your installer or supplier. Failing this please contact the Thermoscreens warranty department. All units are covered by a one year warranty on parts and labour, followed by two additional years parts only.

Care has been taken in compiling these instructions to ensure they are correct, although Thermoscreens disclaims all liability for damage resulting from any inaccuracies and/or deficiencies in this documentation. Thermoscreens retain the right to change the specifications stated in these instructions.

10. RECYCLING & DISPOSAL

This product will offer many years of service when used and maintained in line with these instructions. When the product does need to be disposed of, recycling should be made a priority. Waste electrical products should not be disposed of with household waste.

11. MAINTENANCE PROCEDURES

Filters

The filter should be kept in good order to ensure the unit can operate effectively. Typical symptoms of dirty filters are a reduction in heating/cooling capacities from reduced airflow, increased wear on the fan and increased the noise levels.



The filter is removed by undoing the two retaining screws situated beneath the filter that allows a hinged section to be pulled down giving access to the filter.

The filter is of non-woven nylon manufacture and should be regularly cleaned from the dirty side with a vacuum cleaner or can be partially cleaned by gentle tapping.

After repeated cleaning, the filter performance will become degraded and the filter will need replacing. It is advisable to keep a number of new replacement filters, please contact our sales office for pricing and availability. Stock codes for spares can be found in the spare parts section at the end of this document.

The period between cleaning is dependent on operating conditions. In a very dirty atmosphere, the filter will require frequent cleaning.

The filters are wire framed and the correct way round to install them is with the bare filter frame on the coil side, inside the unit.

Fan Replacement

Internal to the unit is a fan plate fitted with 1 to 5 individual external rotor motor fans. Each fan can be individually removed and replaced using the following procedure.

Step 1 - Isolate the electrical mains supply



Step 2 - Remove access panel by removing the 2 hex headed screws

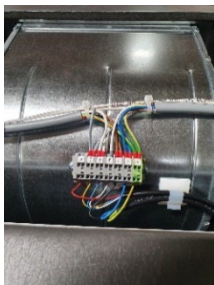

Step 3 - Disconnect (unplug) the fan to be changed from the wiring loom

Step 4 - Whilst supporting the weight of the fan remove the 4 retaining screws that secure the fan to the unit

Step 5 - Remove the fan

Fit the replacement fan by following the above in reverse.

Condensate Drain Trays

Drain trays should be periodically checked to ensure they are clean, unobstructed and free draining. Should they become excessively dirty or blocked, they should be removed and cleaned.

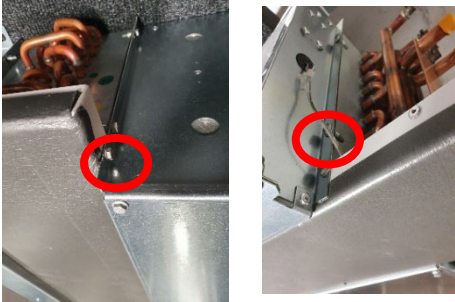

To remove the drain tray you first have to remove the fan access panel as previously described.

The drain pan is secured by 4 screws, two at each end. Once these are removed the drain tray can be lowered.

Coil Maintenance and Removal

Provided the filter is regularly serviced, the coil will require little or no attention. However, if the filter is allowed to get very dirty, some dust will percolate through, and become entrained between the fins. In this case, the element should be cleaned by applying an air jet to the air leaving face.

The coil can be accessed once the fan access panel and drip pan have been removed as previously described.

The coil is secured in place with 8 screws, 4 at each end. Once these are removed the coil can be taken out of the unit.

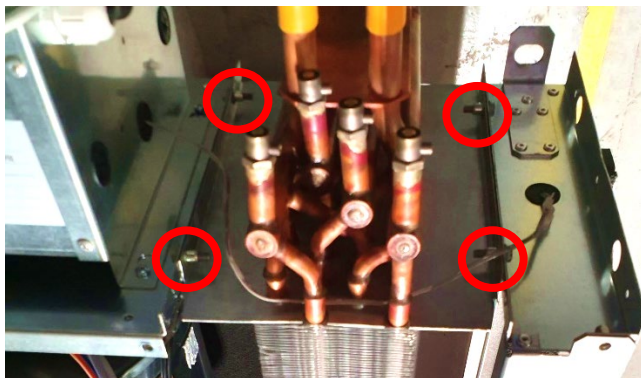

To replace the coil follow the instructions in reverse followed by the drip tray and the fan access panel.

Wiring and Controls

It's likely this product has been supplied with project specific (free issued) controls, for guidance on the controller module inside the electrical box, please refer to the respective controller company's data sheets about unit controls.

Occasionally check that all terminals are tight and that the cable insulation is in good condition. After servicing, ensure that no parts have been disturbed in such a manner that open terminals are short circuited to the unit casing.

Visually inspect the wiring, terminals and all other components for any sign of discolouration, arcing or charring.



Check for blown fuses. If a fuse is blown check the circuits and components it protects thoroughly before re energising. Any blown fuse must be replaced with an equivalent fuse of the same specification, size and rating.

Example - controls enclosure internal wiring

Example – Wiring Diagram

Maintenance Schedule

The unit should be checked at the intervals detailed below to ensure the lifetime of the product is maximized and the efficiency isn't impacted detrimentally. The intervals suggested below are based on a normal environment and the unit should be checked frequently initially to ensure the recommendations are sufficient.

Failure to adhere to the below will reduce performance in the first instance and may impact the products warranty.

	Every 3 Months	Every 6 Months	Every 12 Months
Filters	Yes		
Coil		Yes	
Fan		Yes	
Condensate Tray		Yes	
Controls & Wiring			Yes