

PHV Series. Surface Mounted Range

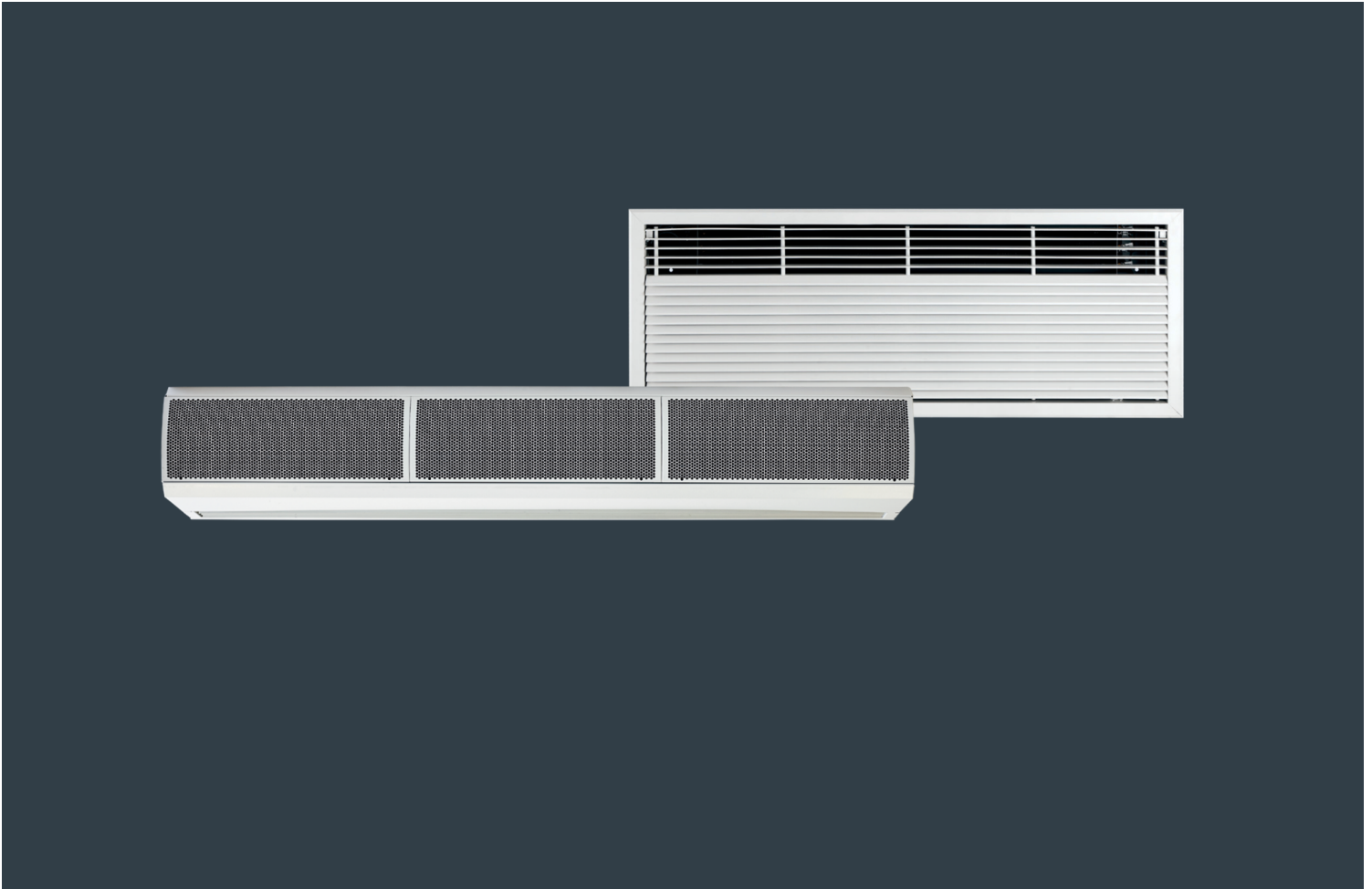

INSTALLATION, OPERATION AND MAINTENANCE INSTRUCTIONS

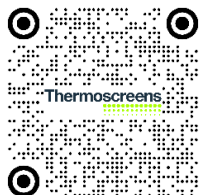

Scan to download the
user guide and App

English

1 CONTENTS

	Page
1 CONTENTS.....	2
2 ELECTRICAL SAFETY	3
3 SPECIFICATIONS	3
4. INTRODUCTION.....	4
5. DELIVERY CONTENTS.....	5
6. TOOLS REQUIRED	5
7. INSTALLATION.....	6
8. ACCESS FOR ELECTRICAL CONNECTION.....	8
9. REMOTE CONTROL INSTALLATION	9
10. REMOTE CONTROL SETTINGS	9
11. EXTERNAL CONTROLS	10
12. MULTIPLE AIR CURTAIN SYSTEMS.....	11
13. SYSTEM CONFIGURATION	12
14. FAN SPEED SELECTION.....	13
15. REMOTE CONTROL OPERATION	13
16. COMMISSIONING THE SYSTEM	15
17. SIGN OFF	16
18. FAULT CONDITIONS	17
19. SERVICE & MAINTENANCE	18
20. WARRANTY.....	19
APPENDIX 1 — Dimensions of PHV Surface Mounted Air Curtain	20
APPENDIX 2A — WIRING DIAGRAM PHV1000E	21
APPENDIX 2B — WIRING DIAGRAM PHV1500E	22
APPENDIX 2C — WIRING DIAGRAM PHV2000E	23
APPENDIX 2D — WIRING DIAGRAM PHV1000W, PHV1500W and PHV2000W	24
APPENDIX 2E — WIRING DIAGRAM PHV1000A, PHV1500A and PHV2000A.....	25
21. DECLARATION OF CONFORMITY	26

2 ELECTRICAL SAFETY

Electrical Supply and Wiring to the Air Curtain

All electrical wiring and connections MUST be carried out by a competent qualified electrician in accordance with the latest edition of national and local wiring regulations and/or local statutory regulations. **“Danger: Disconnect electrical supply before servicing”**

- A 1 phase or 3 phase local isolator having a contact separation of at least 3mm on all poles must be fitted in the electrical supply to the air curtain and located in an accessible position adjacent to the unit.
- The appliance must be connected by cables having an appropriate heat resistant temperature rating.
- All supply cables, circuit breakers and other electrical installation equipment must be correctly sized for the air curtain model being installed; see Section 3: Specifications.
- Models operating on a 3 phase electrical supply - see Section 3: Specifications - require a neutral connection (3N~).
- A 25mm size cable gland or conduit connector of IP21 rating or above should be used for the Electrical Supply into the air curtain.
- See Wiring Diagrams for connecting electrical supply and control cables to the air curtain. The air curtain must be earthed.

3 SPECIFICATIONS

Table 1

Air Curtain Model No	Electrical Supply (V/ph/Hz)	Rated Electrical Power Input (kW)	Rated Current per phase (A)	Heat Output [Low/High] (kW)	Weight (kg)
PHV1000A	230/1/50	0.30	1.3	–	29
PHV1500A	230/1/50	0.40	1.8	–	43
PHV2000A	230/1/50	0.60	2.7	–	58
PHV1000W	230/1/50	0.30	1.3	6.0 / 12.0	35
PHV1500W	230/1/50	0.40	1.8	9.0 / 18.0	47
PHV2000W	230/1/50	0.60	2.7	12.0 / 24.0	64
PHV1000E	400/3/50	12.30	18.7	6.0 / 12.0	32
PHV1500E	400/3/50	18.40	27.9	9.0 / 18.0	45
PHV2000E	400/3/50	24.60	37.5	12.0 / 24.0	62

4. INTRODUCTION

Established in the 1960s, Thermoscreens is a leading air curtain manufacturer that exports to over 60 countries worldwide.

As with all our products, the PHV range of air curtains is designed with energy efficiency in mind.

PHV models suffixed E, W or A are designed to be surface mounted inside a building and located horizontally over a doorway.

They must not be installed on the outside of a building or built into a cabinet or recessed in any way.

Please complete the following details for your reference:

Date of Purchase
Place of Purchase
Serial Number

Proof of purchase is required to make a claim under warranty.



Thermoscreens
St. Mary's Road
Nuneaton
Warwickshire
England
CV11 5AU

Email: sales@thermoscreens.com — <http://www.thermoscreens.com>

Tel: +44 (0) 24 7638 4646 — Fax: +44 (0) 24 7638 8578

5. DELIVERY CONTENTS

The following items are supplied in the box at delivery.

NOTE: If any parts are missing or damaged contact your place of purchase.

PHV Surface Mounted Air



Note: End caps are supplied loose to be fitted during installation

Touch Remote Control (for Electric and Water Heated units)



Supplied with 6m RJ Control Cable

Ambient Remote Switch (for Ambient units)



Wall Brackets and M6 Fixing Bolts



3 brackets for C1500 & C2000 units

3-port control valve (for water heated units)



Fitted in pipework to air curtain by installer

Outdoor Air Thermostat (Optional – supplied by Installer)



Used for simple weather compensation control (disables heating on a warmer day)

6. TOOLS REQUIRED

The following tools are required for installation:

- Flat blade screwdrivers
- Pozi head screwdrivers
- 10mm spanner
- Adjustable spanner
- Electric drill
- Ladders
- Appropriate lifting equipment

7. INSTALLATION

The air curtain is designed to be located horizontally over a doorway. It must not be installed outside of the building.

7.1 Location

Mount the air curtain above and as close to the doorway as possible, with:

- the discharge grille not more than 4m above floor level
- at least 100mm clearance (air gap) above electric/water heated air curtains, see Fig 1

Beware of doorway top edges, structural beams, door opening/closure devices, etc., which may interfere with the air stream and affect the location of the unit.

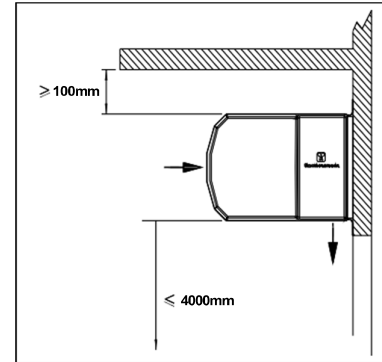

Fig 1

NOTE: For the air curtain to work well the width of the open doorway should be less than the length 'A' of the air curtain, see Appendix 1.

7.2 Wall Fixing

NOTE: Use suitable wall fixing bolts (not supplied) to fix the unit to the wall, taking into account the type of wall and the weight of the unit (see section 3: Specifications).

- Step 1** Bolt all wall brackets to the rear face of the unit as shown in Fig 2, using the M6 fixing bolts supplied.
- Step 2** Drill fixing points in the wall, referring to Appendix 1 for correct positioning.
- Step 3** Screw in the top wall bolts leaving a small gap between the screw head and the wall.
- Step 4** Lower the unit onto the bolts via the key-hole slots in the top of the wall brackets and screw in the bottom wall bolts.
- Step 5** Tighten all fixing bolts until the air curtain is safely secured to the wall.



Fig 2

7.3 Ceiling Suspension

M10 threaded rods (not supplied) are used to suspend the unit from the ceiling.

Suspend the unit from the ceiling as follows:

Step 1 Screw the threaded rods into all of the holes in the top face of the unit as shown in Fig 3.

NOTE: Do not screw hanging rods too far in as they could interfere with internal components.

Step 2 Fit M10 locking nuts (not provided) to prevent the rod rotating and coming away from the casing.

Step 3 Secure each suspension rod to a suitable structure that can support the weight of the unit (see section 3: Specifications for weights).



Fig 3

WARNING: It is the sole responsibility of the installer to ensure that the fixing locations and suspension system used are suitable for the air curtain being installed.

7.4 LPHW Models

For LPHW models ensure that water isolation valves are fitted in the flow and return pipework adjacent to the air curtain and connected correctly as shown in the diagram in Appendix 1.

For the design of the water pipework system and pump, water flow rates and pressure drops for maximum heat output of the air curtain are given in Table 2 below.

Table 2

Air Curtain	Water Flow Rate (l/min at 82/71°C)	Water Pressure Drop (kPa)
PHV1000W, 2-row (12kW)	15.6	5.0
PHV1500W, 2-row (18kW)	23.4	9.5
PHV2000W, 2-row (24kW)	31.2	14.7
Air Curtain	Water Flow Rate (l/min at 60/40°C)	Water Pressure Drop (kPa)
PHV1000W, 3-row (12kW)	8.6	9.7
PHV1500W, 3-row (18kW)	12.9	10.0
PHV2000W, 3-row (24kW)	17.1	18.3

NOTE: Water Pressure Drop is across the flow and return pipework to the air curtain and includes for the coil fitted inside the unit and the valve fitted in the heating pipework to the unit.
Water flow rates and pressure drops at different water temperatures can be calculated using the Thermoscreens coil calculation programme. Visit the Thermoscreens website for details.

The installer must connect the 3-port valve in the heating pipework as shown in Figure 4 below:

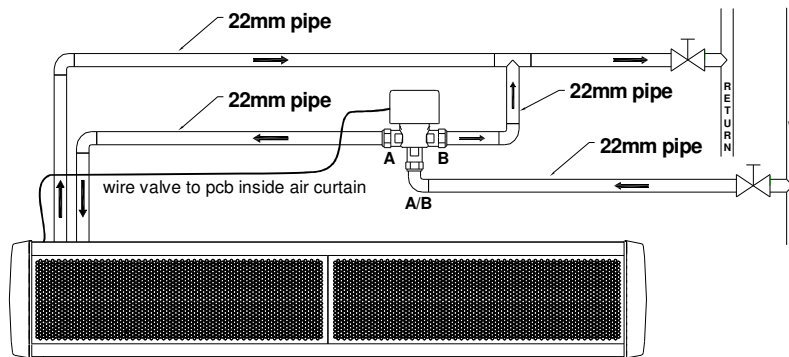

Fig 4

8. ACCESS FOR ELECTRICAL CONNECTION

8.1 How to access terminals

To gain access to the air curtain for connection and commissioning, remove air inlet grilles and bottom access panel as explained below.

First remove the plastic end caps at each end of the unit, if fitted, by pulling off to the side.

NOTE: All air curtain panels are protected in a plastic film. When access panels are removed this film can be removed.

8.1.1 Remove air inlet grilles

Using a Pozi No 1 screwdriver, remove each grill with its filter.

To remove, insert screwdriver into the elongated hole at the bottom corner of the grille (see Fig 5) and turn the screw one quarter of a turn anticlockwise.

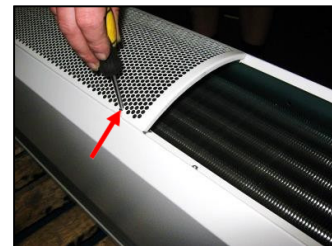

Fig 5

8.1.2 Remove bottom access panel

Unfasten the securing screw at each end (see 1, Fig 6) and, if applicable, two screws in the centre (PHV1500 and PHV2000 units only).

To remove, slide the access panel (see 2, Fig 6) out forwards.



Fig 6

9. REMOTE CONTROL INSTALLATION

Mount the Touch Controller in a convenient position directly to the wall or onto a switch box.

9.1 Wall mounting

- Step 1** Press release button on side of Controller case and pull the back case away (see Fig 7).
- Step 2** Feed one end of the RJ control cable through the back case, secure it, then screw the back case to the wall using suitable fixings (not supplied).
- Step 3** Connect the RJ plug to the RJ socket on the PCB in the remote control.
- Step 4** Refit the front case.

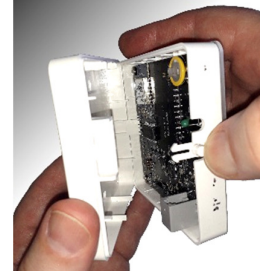

Fig 7

9.2 Switch box mounting

- Step 1** Press release button on side of Controller case and pull the back case away (see Fig 7).
- Step 2** Feed one end of the RJ control cable through the switch box, feed and secure the RJ control cable through the back case and secure back case to switch box using 2 mounting screws (not supplied) (see Fig 8).
- Step 3** Connect the RJ plug to the RJ socket on the PCB in the remote control
- Step 4** Refit the front case.

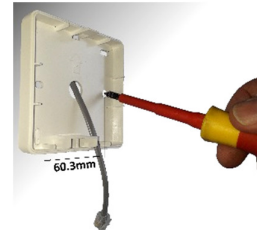

Fig. 8

10. REMOTE CONTROL SETTINGS

Touch Controller with four default software Flag settings provide following optional features, as Table 3. If required, software Flag values can be changed by entering advanced settings as below.

With Controller ON, long press both Up and Down touchpad – 01 Flag menu displayed on screen
Tap Home touchpad to detail Flag 01 Reset on power-up

Follow instructions on LCD screen with:

- Tap Speed touchpad to cycle Flags 1 to 4
- Tap Up or Down touchpad to change selected Flag value

Tap Home touchpad to confirm value

Table 3

FLAG	Feature	Explanation	Default	Notes
1	Reset on power-up	On restoring power after an electrical interruption all Remote Control settings are retained	01 (ON)	WARNING! – Fans start on their own after power is restored
2	Stop fan on cold	Fans are switched off when heating level is achieved (AUTO mode only)	00 (OFF)	
3	Never blow cold	Air curtain always heats in AUTO mode	00 (OFF)	Will not go to ambient mode
4	Room air temperature control	Enables the room air sensor in the Remote Control	00 (OFF)	Disables all other temperature sensors

11. EXTERNAL CONTROLS

11.1 Remote switch contacts IN0, IN1

Terminals IN0 and IN1 on the CCS PCB inside the air curtain can be used to provide different control strategies using remote volt-free contacts (see Fig 9). This could be to provide remote On/Off from a timer or BMS Digital/Output contact, to work with a door switch or for simple weather compensation control to disable heating when outdoor air temperatures become warmer. Table 4 describes the different functions:

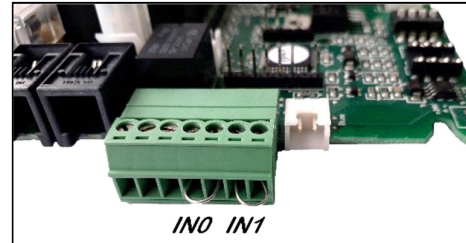







Fig 9

Table 4

Function	IN0		Notes
			
Remote On/Off (INHIBIT)	Unit operates normally in MANUAL Mode or AUTO Mode from the Remote Control	Unit switches off after 15s, with fan run-on at Medium fan speed if DIP 2 = OFF	Use the Remote Control to set up unit and then hide it away if required. * On/Off is then done via IN0 using a remote volt-free contact.

Function	IN1		DIP 4	IN0	Notes
					
Door Switch Control	After 30s the heating is disabled and the fan goes to low speed	Unit operates normally in MANUAL Mode or AUTO Mode from the Remote Control	ON		Door Open:- Normal Control Door Closed:- Heating Off Low Fan Speed
Summer Winter	Unit operates normally in MANUAL Mode or AUTO Mode from the Remote Control <i>COLD DAY</i>	Heating is disabled straight away, Fan speeds operate normally from the Remote Control <i>WARM DAY</i>	OFF		Simple weather compensation control using an outdoor air thermostat with volt free contacts (see Section 11.3)

NOTE: Wire volt-free, remote switch contacts to 2-way screw terminals IN0 and IN1 using 2-core cable.

WARNING: Do not apply any voltage to terminals IN0 and IN1 as this will damage the CCS PCB inside the air curtain.

* **NOTE:** The Controller must stay plugged-in for the air curtain to keep working. An optional plug-in EEPROM is available from Thermoscreens so the Remote Control can be unplugged and the air curtain stay working. Visit the Thermoscreens website for details.

11.2 Overheat safety cut-out indication

For electric heated air curtains the CCS PCB includes a fault indication signal for if the overheat safety cut-out on the electric heater operates.

Volt free changeover contacts (1A 240VAC 30VDC) can be wired via the 7-way screw terminal (see Fig 10).

Refer to Section 18.1: Overheat Safety cut out, for how to reset a overheat safety cut-out situation.

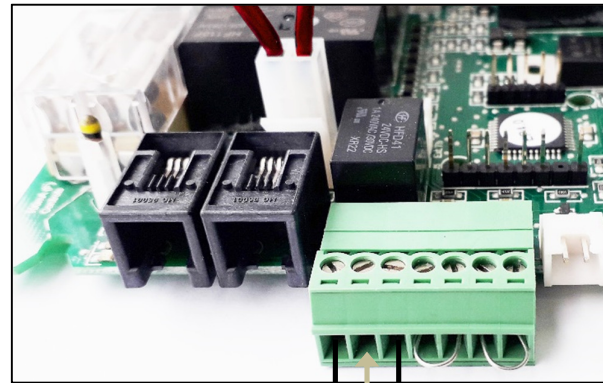

Fig 10

NO
HEALTHY
C
NC
ALARM!
C

11.3 Weather compensation control (Summer/Winter)

To save heating energy on warmer days a simple weather compensation (Summer/Winter) heat control strategy can be used. Fit an outdoor air thermostat with volt-free contacts (supplied by the installer) to a north facing wall.

Use a 2-core cable to connect the outdoor air thermostat to 2-way terminal IN1 on the CCS PCB (see Fig 11)

On the CCS PCB, set DIP 4 to OFF as per Table 4, (see Section 11.1: Remote switch contacts IN0, IN1).

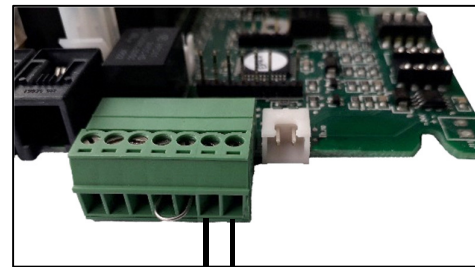

Fig 11

Switch Contact Closed = Heating Enabled (cold day)
Switch Contact Open = Heating Disabled (warm day)



WARNING: Do not apply any voltage to terminal IN1 as this will damage the CCS PCB.

NOTE: To promote increased energy saving a more advanced weather compensation control strategy is available from Thermoscreens. Using a heating curve, the discharge air temperature of the airstream coming from the air curtain is controlled against the outside air temperature. Visit the Thermoscreens website for details.

12. MULTIPLE AIR CURTAIN SYSTEMS

For master/slave control, plug and connect units together with Thermoscreen RJ extension cables (not supplied) as per Figure 12 below. Each air curtain must have its own electrical supply.

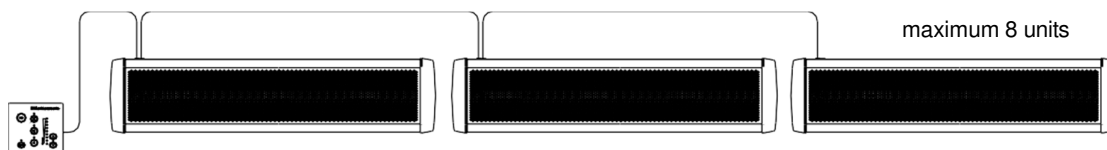

Fig 12

13. SYSTEM CONFIGURATION

13.1 Optional features

WARNING: Isolate and disconnect air curtain from the power source before making any changes.

DIP switches on the air curtain CCS PCB (see Fig 13) provide the following optional features, as explained below:

- Fan heat interlock
- Disable fan run-on
- Thermostat master (for master/slave installations)
- Weather compensation heat control (Summer/Winter)
- Door switch control

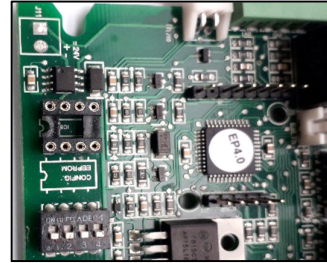

Fig 13

Feature	DIP setting	Default	Notes
<p>Fan heat interlock Allows fan speed to govern heat output on electric heated units.</p> <p>If low or medium fan speed is selected, a lower heat output results. High heat operates only on high fan speed.</p>	<p>DIP 1</p>	<p>ON</p> <p>Heat output is governed by fan speed.</p>	<p>This feature is only used with electric heated air curtains to limit very high air temperatures.</p> <p>Set DIP1 to OFF if unit is water heated or ambient.</p>
<p>Disable fan run-on The 2 minute fan run-on after switch off is enabled or disabled on electric heated air curtains.</p>	<p>DIP 2</p>	<p>OFF</p> <p>Fan run-on at medium speed enabled.</p>	<p>Must only be used for water heated or ambient air curtains. Each air curtain must have DIP2 set to ON for no fan run-on.</p>
<p>Thermostat master For master/slave installations. Only the air sensor in the thermostat master air curtain is used to measure air temperature.</p> <p>Set DIP 3 to ON in the air curtain that will be the master unit.</p>	<p>DIP 3</p>	<p>OFF</p> <p>Air curtains in master/slave systems all act independently.</p>	<p>Air sensor thermistors in all slave air curtains will be ignored.</p> <p>Stops some units blowing cold air and others blowing warm air in master/slave systems on larger doorways.</p>
	<p>DIP 4</p>	<p>OFF</p> <p>IN1 Weather compensation</p> <p>ON</p> <p>IN1 Door switch</p>	<p>See section 11.1 Remote Switch Contacts IN0 and IN1 for details</p> <p>Weather compensation control is the same as Summer/Winter control</p>

NOTE: ■ — Black rectangle is moveable head of DIP switch.

NOTE: A range of advanced factory fitted and plug-in control options are available from Thermoscreens to enhance the performance of the CCS PCB controller inside the air curtain. These include advanced weather compensation control using a heating curve, outlet air temperature control, ECObus® BACnet/Modbus BMS control, modulating heater outputs and EEPROMs for non-standard control strategies. Visit the Thermoscreens website for details.

14. FAN SPEED SELECTION

Factory settings for the 3 fan speeds are shown in Table 5 below:

(refer also to wiring diagrams in Appendix 2)

Table 5

Fan Speed	Maximum air velocity at outlet grille (m/s)	Maximum air curtain mounting height (m)	Sound Pressure Level of air curtain [dB(A) at 3m]	Air Volume Flow Rate (m ³ /h) [for E & A]
HIGH (black wire)	11.0	4.0	PHV1000 - 59 PHV1500 - 60 PHV2000 - 61	2880 4020 5760
MEDIUM (blue wire)	–	–	PHV1000 - 57 PHV1500 - 57 PHV2000 - 59	2585 3815 5170
LOW (red wire)	–	–	PHV1000 - 56 PHV1500 - 53 PHV2000 - 58	2420 3690 4840

Sound pressure levels dB(A) at 3m distance are for a single air curtain mounted at its maximum mounting height, operating in a room with average acoustic characteristics as defined in CIBSE Guide B5 (reverberation time 0.7s at 1kHz) and a room size equivalent to 8 air changes per hour (ac/h). Care needs to be taken when selecting air curtains for an installation as noise levels can be several dB higher if the mounting height is reduced, if the room is more 'live' (i.e. hard surfaces, no furnishings or absorbent materials), if the room is smaller than 8 ac/h equivalent or a combination of these factors. Noise levels will also increase if more than one air curtain is installed at the same doorway (e.g. +3dB(A) for 2 equal point sources: direct field).

15. REMOTE CONTROL OPERATION

15.1 Remote Control Switch (for Ambient units)

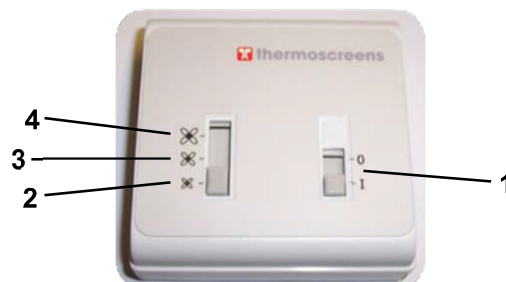

1 On/Off

Turns the air curtain fans On or Off.

2, 3 & 4 Fan speed

Switch fan speed between Low, Medium and High respectively.

15.2 Touch Controller (for Electric and Water Heated units)

Please scan QR code and follow links to access the user guide and download App.



Home Speed Up Down

Controller connected via RJ communications lead to CCS PCB with Home, Speed, Up and Down touchpads below the LCD screen as detailed above.

On/Off

Press and hold Home touchpad for 2 seconds to turn air curtain ON or OFF.

NOTE: If an electric heated air curtain is heating when switched off the fan will run-on for approximately 2 minutes to dissipate excess heat.

Manual/Automatic

With Controller turned ON tap Home touchpad to switch between Automatic and Manual mode.

The screen displays either **A** for "Auto Mode" or **M** for "Manual Mode".

Heating level control

Manual mode



Select heating level and cycle between zero, half heat  and to full heat  with each short Up or Down touchpad press.

Automatic mode

Heat output is controlled automatically according to inlet air and the desired temperatures. The inlet air temperature is the upper temperature indication on the Controller adjacent to  on the LCD screen.

Fan speed

Short press Switch touchpad to switch and cycle fan speed:

- low 
- Medium 
- High 

Date and Time Settings

Configure Date and Time settings either via App or on Controller as below.

Turn Controller ON and hold Speed touchpad for 2 seconds

Follow instructions on LCD screen with:

- Tap Up touchpad to increase value
- Tap Down touchpad to decrease value
- Tap Speed touchpad to confirm values

16. COMMISSIONING THE SYSTEM

16.1 Verify system operation

To commission the system, verify the following conditions are met:

- All fans are working.
- Fans operate at Low, Medium and High speeds.
- There is no excessive mechanical noise coming from the fans.
- When heating is selected, the air stream from the discharge grille warms up across the whole length of the air curtain.
- When set to manual with fans set to high speed, heating increases as higher heat is selected.
- Warm air reaches across the doorway with door open or closed.
- For electric and water heated air curtains Controller operates correctly in both manual and auto modes.

16.2 Instruct customer and hand over

Before leaving site, hand over the installation to the customer/end user or their representative.

Explain that any person operating the air curtain must be given supervision and instruction by the person responsible for their safety, concerning the safe use of the unit and to understand any hazards involved. Children and those with reduced physical, sensory or mental capabilities should not operate the air curtain.

Recommend that the doorway should be closed whenever possible but that during times of high pedestrian use it will become an 'open doorway'. The air curtain then serves an essential purpose by saving energy and providing comfort to occupants.

Explain that the inlet grilles and air filters (if fitted) must be cleaned regularly and the unit serviced at schedule intervals – see section 19: Service & Maintenance.

NOTE: Leave these instructions with the customer/end user or their representative!!

17. SIGN OFF

Complete the following once commissioning is completed:

Installer signature		Customer signature	
Installer name		Customer name	
Installer company		Customer company	
Date		Date	

18. FAULT CONDITIONS

An overheat fault in electric heated units may cause the overheat safety cut-out(s) to operate.

Before resetting ensure there is adequate air flow from the air curtain and the unit has been commissioned as per section 16.

18.1 Touch Controller Reset Overheat Safety cut-out

This is indicated by flashing warning symbol on Touch Controller and a red status LED on the CCS PCB inside the air curtain.

To reset a overheat safety cut-out:

- Step 1** Switch off the electrical supply to the air curtain.
- Step 2** Allow time for the air curtain to cool down, typically 10 minutes.
- Step 3** Switch on the electrical supply to the air curtain.
- Step 4** If Controller is switched off, press and hold Home button for 2 seconds to turn Controller ON.
- Step 5** Press the Home touchpad on Controller 8 times.

Air curtain heaters will then operate and after 30 seconds the Controller warning symbol will disappear and status LED on CCS PCB flash green.

18.2 Fuses

In the event of an electrical fault internal electrical fuses may operate.

There are two internal fuses located on the CCS PCB inside the air curtain:

- Fuse 6.3A(T) supplies the fan motors within the air curtain
- Fuse 100mA(F) controls the circuitry of the CCS PCB

18.3 CCS PCB status indication

There is a status LED on the CCS PCB inside the air curtain (See LED shown on Wiring Diagrams in the Appendix).

This indicates the status of the CCS Controls as follows:

1. LED flashing green – operation normal
2. LED flashing red – low supply voltage, remote control not plugged in or RJ cable fault
3. LED permanently red – overheat safety cut-out(s) open circuit from an overheat situation (see Section 18: Fault Conditions for how to reset)

19. SERVICE & MAINTENANCE

WARNING: Failure to adequately maintain the unit and provide a suitable cleaning schedule will result in a loss of performance and reduced life expectancy of the air-curtain and possible overheating and fire risk with electric heated units.

19.1 Every week

NOTE: Weekly maintenance can be carried out by the Cleaner or Janitor from floor level.

Turn off the air curtain to prevent entry of dust then clean the face of the air inlet grilles and air filters inside the grilles using a vacuum cleaner with an extension tube and brush.

19.2 Every 3 months

WARNING: Before servicing, isolate and disconnect the air curtain from the electrical power.

WARNING: The following servicing and maintenance must be carried out by a competent electrician or a Thermoscreens appointed technician.

Clean and inspect the inside of the air curtain as follows:

- Step 1** Remove plastic end caps at each end of the unit by pulling off to the side.
- Step 2** Use a Pozi No.1 screwdriver to remove air inlet grilles by releasing the fasteners at the bottom corners of each air inlet grille. See Fig 5, Section 8.1.1.
- Step 3** Clean and remove any build-up of dust and dirt within the air-curtain (inlet/outlet grilles, electric heaters, fan impellers, housings and motors) using a vacuum cleaner and soft brush.

NOTE: Build-up of dirt on fan impellers can cause vibration, noise and excessive wear on the motor bearings.

- Step 4** Check within the unit to ensure all electrical connections and crimped terminals are tight and that all cables are in good condition.

Refit air inlet grilles after servicing. Reconnect electrical supply and test to ensure correct operation (see Section 16: Commissioning).

20. WARRANTY

All units are covered by a two year warranty.

Failure to adequately maintain the unit may void the warranty. If any problems are encountered, please contact your installer/supplier.

Failing this please contact the Thermoscreens warranty department.

Care has been taken in compiling these instructions to ensure they are correct. Thermoscreens disclaims all liability for damage resulting from any inaccuracies and/or deficiencies in this documentation. Thermoscreens retain the right to change the specifications stated in these instructions.

Thermoscreens
St. Mary's Road Nuneaton
Warwickshire England
CV11 5AU

Email: sales@thermoscreens.com
Tel: + 44 (0) 24 7638 4646
Fax: + 44 (0) 24 7638 8578
www.thermoscreens.com

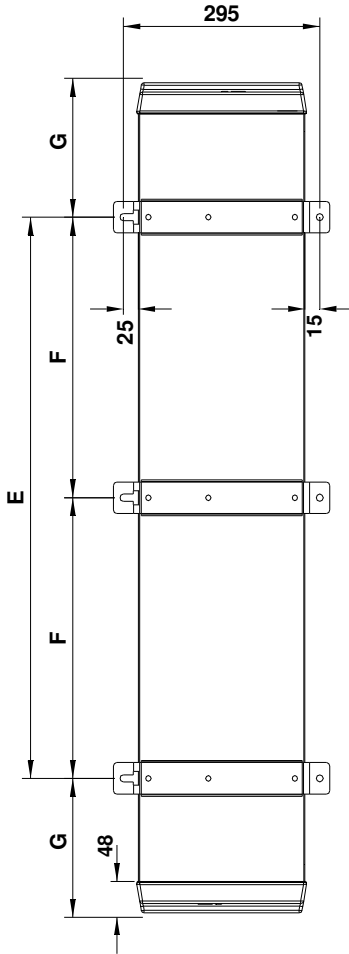
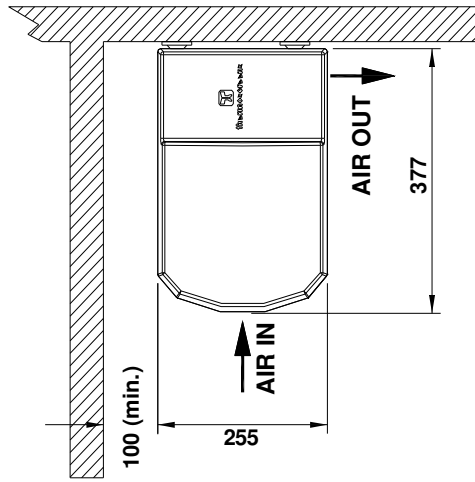

mm



Entry point for electrical supply and controls

Remote control connection interface

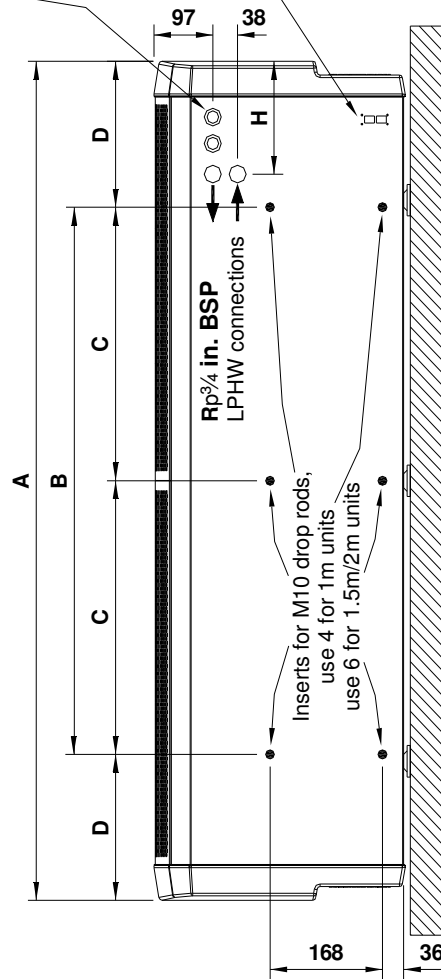

	PHV1000	PHV1500	PHV2000
A	1196	1746	2296
B	800	1400	1896
C	-	700	948
D	198	173	200
E	800	1300	1824
F	-	650	912
G	198	271	236
H	226	271	228

APPENDIX 1 — Dimensions of PHV Surface Mounted Air Curtain

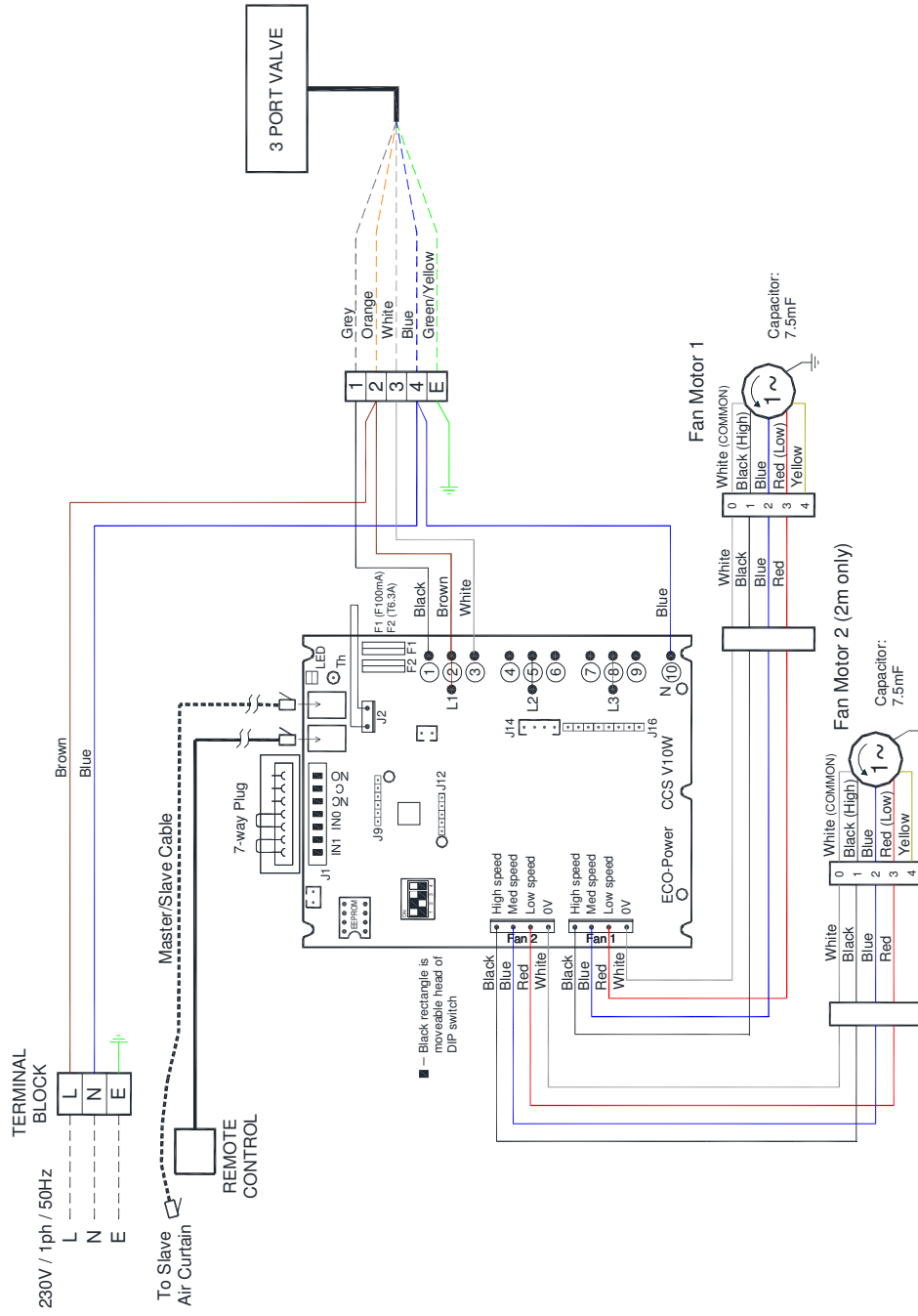

APPENDIX 2D — WIRING DIAGRAM PHV1000W, PHV1500W and PHV2000W

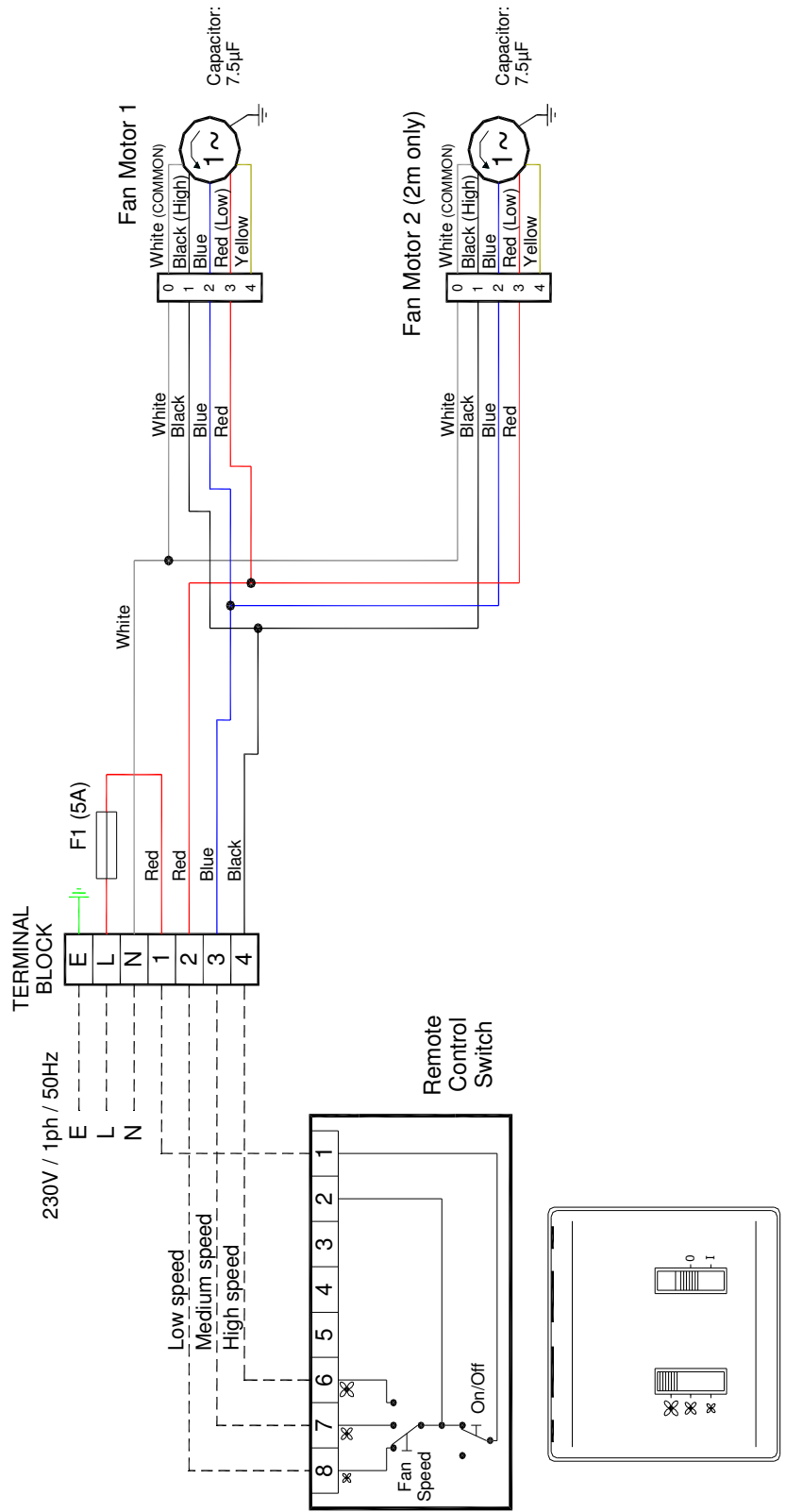

APPENDIX 2E — WIRING DIAGRAM PHV1000A, PHV1500A and PHV2000A

21. DECLARATION OF CONFORMITY

Carver International Ltd T/A Thermoscreens
St Mary's Road Nuneaton
Warwickshire
CV11 5AU
United Kingdom
Telephone: +44 (0)24 7638 4646 www.thermoscreens.com



EC DECLARATION OF CONFORMITY
as defined by the EC Council Directive on Machinery 2006/42/EC,
the Low Voltage Directive 2014/35/EC, Electromagnetic Compatibility Directive 2014/30/EC, the
Energy related Products Directive 2009/125/EC

Herewith we declare that the air movement equipment designated below, on the basis of its design and construction in the form brought onto the market by us in accordance with the relevant safety, health and performance requirements of the Machinery. If alterations are made to the machinery without prior consultations with us, this declaration becomes invalid. This declaration of conformity is issued under the sole responsibility of the manufacturer.

Designation of Equipment: AIR CURTAINS

Series Type: PHV1000A; PHV1000E; PHV1000W; PHV1500A; PHV1500E; PHV1500W;
PHV2000A; PHV2000E; PHV2000W
(in Casing Styles: Surface Mount and Recessed)

Relevant EC Council Directives: the Machinery Directive (2006/42/EC)
the Low Voltage Directive (2014/35/EU)
the Electromagnetic Compatibility Directive (2014/30/EU)
the Pressure Equipment Directive (97/23/EC)
the EcoDesign Products Directive (2009/125/EC;Comm. Reg.327/2011)
the Restriction of Hazardous Substances Directive (2017/2102)

The object of the declaration described above is in conformity with the relevant Union harmonisation legislation:

Machinery -	BS EN ISO 12100:2010, BS EN ISO 13857:2008
LVD -	EN 60335-1:2012+A11:2014, EN 60335-2-30:2009+A11:2012
EMC -	EN 61000-6-1:2007, EN 61000-6-3:2007+A1:2011, EN 61000-3-2:2014 + A2:2009, EN61000-3-3:2013
PED -	EN 13133:2000, EN 13134:2000
ErP -	Commission Regulation (EU) No.327/2011, ISO 5801:2007, ISO 12759:2010
RoHS -	EN 63000:2018

Basis of Self Attestation: Quality Assurance to BS EN ISO 9001: 2008
B.S.I. Registered Firm Certificate Number FM 85224 SGS Test
Report ELS150049/2/R/DC/11;
SGS Test Report EMC150049/1
CE Marking Association Test Report 6799 and 6800

Responsible Person: Carole Keane, Group Marketing Director.

Date: 1st April 2020

Signed:

A handwritten signature in black ink that reads "Carole Keane". The signature is written in a cursive style with a large initial 'C'.

