

C Series. Recessed Range



INSTALLATION, OPERATION AND MAINTENANCE INSTRUCTIONS

English

1. CONTENTS

	Page
1. CONTENTS	2
2. ELECTRICAL SAFETY	3
3. SPECIFICATIONS	3
4. INTRODUCTION	4
5. DELIVERY CONTENTS	5
6. TOOLS REQUIRED.....	5
7. INSTALLATION	6
8. LPHW MODELS	9
9. REMOTE CONTROL INSTALLATION	10
10. REMOTE CONTROL SETTINGS.....	10
11. EXTERNAL CONTROLS.....	11
12. MULTIPLE AIR CURTAIN SYSTEMS.....	12
13. SYSTEM CONFIGURATION.....	13
14. FAN SPEED SELECTION	14
15. REMOTE CONTROL OPERATION.....	14
16. COMMISSIONING THE SYSTEM.....	16
17. SIGN OFF	16
18. FAULT CONDITIONS	17
19. SERVICE & MAINTENANCE	18
20. WARRANTY	19
APPENDIX 1 — DIMENSIONS OF C RECESSED AIR CURTAIN.....	20
APPENDIX 2A — WIRING DIAGRAM C1000E, C1500E and C2000E	21
APPENDIX 2B — WIRING DIAGRAM C1000W, C1500W and C2000W	22
APPENDIX 2C — WIRING DIAGRAM C1000A, C1500A and C2000A	23
20. DECLARATION OF CONFORMITY	24

2. ELECTRICAL SAFETY

Electrical Supply and Wiring to the Air Curtain

All electrical wiring and connections MUST be carried out by a competent qualified electrician in accordance with the latest edition of the IEE wiring regulations and/or local statutory regulations.

- A 1 phase or 3 phase local isolator having a contact separation of at least 3mm on all poles must be fitted in the electrical supply to the air curtain and located in an accessible position adjacent to the unit.
- The appliance must be connected by cables having an appropriate heat resistant temperature rating.
- All supply cables, circuit breakers and other electrical installation equipment must be correctly sized for the air curtain model being installed; see Section 3: Specifications.
- Models operating on 3 phase electrical supply - see Section 3: Specifications - require a neutral connection (3N~).
- A 25mm size cable gland or conduit connector of IP21 rating or above should be used for the Electrical Supply into the air curtain.
- See Wiring Diagram for connecting electrical supply and control cables to the air curtain. The air curtain must be earthed.

3. SPECIFICATIONS

Table 1

Air Curtain Model No	Electrical Supply (V/ph/Hz)	Rated Electrical Power Input (kW)	Rated Current per phase (A)	Heat Output [Low/High] (kW)	Weight (kg)
C1000AR	230/1/50	0.15	0.7	–	19
C1500AR	230/1/50	0.20	0.9	–	25
C2000AR	230/1/50	0.25	1.1	–	35
C1000WR	230/1/50	0.15	0.7	3.0 / 6.0	22
C1500WR	230/1/50	0.20	0.9	4.5 / 9.0	30
C2000WR	230/1/50	0.25	1.1	6.0 / 12.0	41
C1000ER	400/3/50	9.15	13.7	4.5 / 9.0	20
C1500ER	400/3/50	12.20	18.3	6.0 / 12.0	27
C2000ER	400/3/50	18.25	27.2	9.0 / 18.0	37

4. INTRODUCTION

Established in the 1960s, Thermoscreens is a leading air curtain manufacturer that exports to over 60 countries worldwide.

As with all our products, the C recessed range of air curtains are designed with energy efficiency in mind.

C models suffixed ER, WR or AR are designed to be recess mounted inside a building and located horizontally over a doorway.

They must not be installed on the outside of a building.

Please complete the following details for your reference:

Date of Purchase
Place of Purchase
Serial Number

Proof of purchase is required to make a claim under warranty.



Thermoscreens Ltd
St. Mary's Road
Nuneaton
Warwickshire
England
CV11 5AU

Email: sales@thermoscreens.com — <http://www.thermoscreens.com>

Tel: +44 (0) 24 7638 4646 — Fax: +44 (0) 24 7638 8578

5. DELIVERY CONTENTS

The following items are supplied in the box at delivery.

NOTE: If any parts are missing or damaged contact your place of purchase.

C Recessed Air Curtain



Ecopower Remote Control (for Electric and Water Heated units)



Remote Control Switch (for Ambient units)



Supplied with 6m
RJ Control Cable

Recessed Grille



The recessed grille is
supplied separately

3-port control valve (for water heated units)



Fitted in pipework to
air curtain by installer

Outdoor Air Thermostat (Optional – supplied by Installer)



Used for simple weather
compensation control
(disables heating on a warmer day)

6. TOOLS REQUIRED

The following tools are required for installation:

- Flat blade screwdrivers
- Pozi head screwdrivers
- 10mm spanner
- Adjustable spanner
- Electric drill
- Ladders
- Appropriate lifting equipment
- Appropriate tools for cutting ceiling aperture

7. INSTALLATION

The air curtain is designed to be recessed within ceiling voids or bulkheads within a building and located horizontally over a doorway. It must not be installed outside of the building.

7.1 Location

Mount the air curtain above and as close to the doorway as possible, with:

- the recessed grille not more than 2.75m above floor level
- the air discharge (see 1, Fig 1) section of the recessed grille nearest the doorway and the air inlet section (see 2, Fig 1) furthest from the doorway

Beware of doorway top edges, structural beams, door opening/closure devices, etc., which may interfere with the air stream and affect the location of the unit.

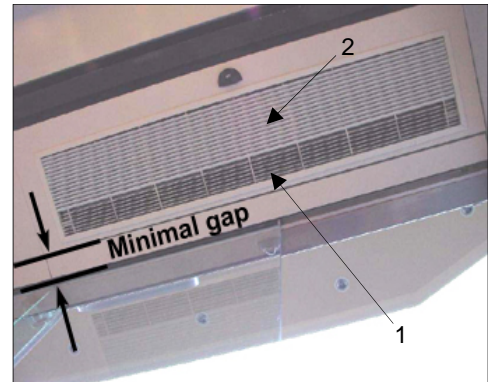

Fig 1

NOTE: For the air curtain to work well the doorway should be less than the width of the airstream.

7.2 Ceiling Suspension

Step 1 Cut an aperture in the ceiling to the dimensions in Appendix 1. Cut notches, if necessary, to clear screws in the air curtain casing.

NOTE: For LPHW models, pipework will need to be installed above the curtain. Allow sufficient access and height clearance within the ceiling void to do this.

Step 2 Fix M8 threaded rods (not supplied) through the 2 holes at each end in the top casing (see Fig 2). Feed the rods through the casing and attach to fixing brackets near the bottom of the unit (see Fig 3, looking up into the air curtain). Use M8 lock-nuts either side of fixing brackets to secure hanging rods.

NOTE: Do not let these four hanging rods come below the bottom of the unit casing or they may prevent the recessed grille fitting properly.

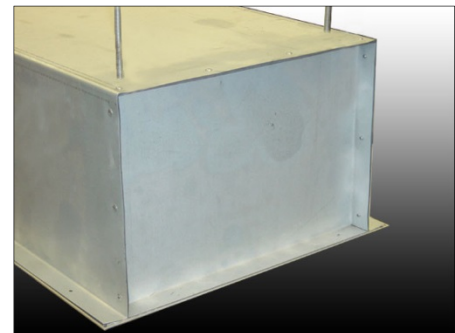

Fig 2

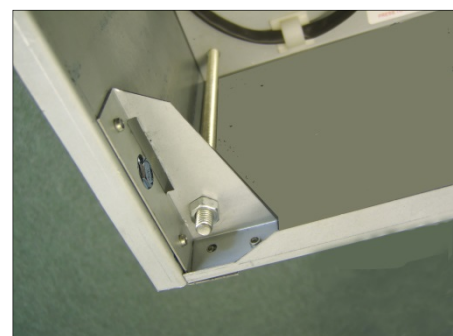

Fig 3

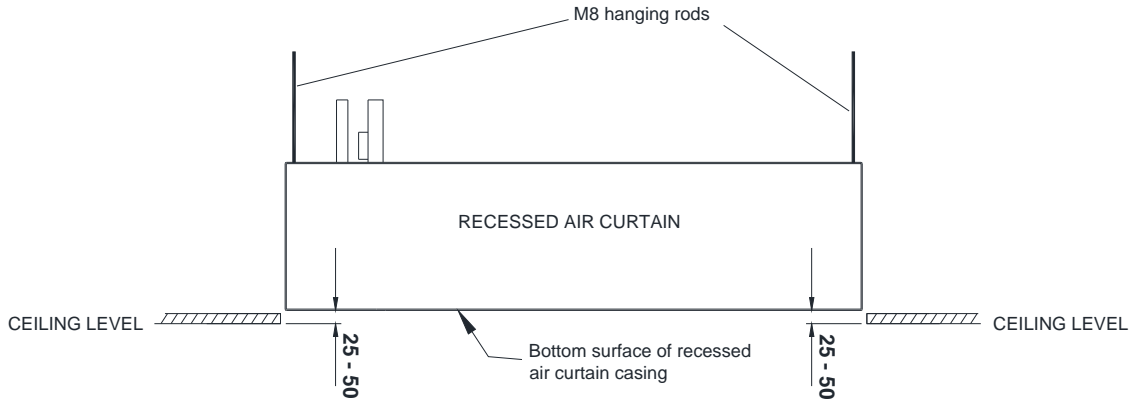

Fig 4

Step 3 Secure each rod to a suitable structure that can support the weight of the unit (see Section 3: Specifications for weights).

Step 4 Adjust the height of the unit on its hanging rods so the bottom surface of the casing goes between 25-50mm up into the ceiling as shown in Fig 4. Ensure the unit is level.

WARNING: It is the sole responsibility of the installer to ensure that the fixing locations and suspension system used are suitable for the air curtain being installed.

7.3 Attaching the recessed grille to the air curtain

The recessed grille consists of:

- Metal frame
- Hinged inlet/discharge grille
- Slotted fixing brackets

There are 4 fixing slotted brackets on the C1000R, C1500R and 6 brackets on the C2000R (see Fig 5).

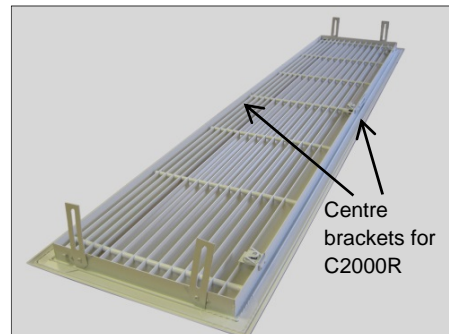

Fig 5

Fix the grille as follows:

Step 1 Open the hinged inlet grille using a flat bladed screwdriver to release the quarter turn fasteners (see Fig 6). There are two fasteners on the C1000R unit and three fasteners on C1500R and C2000R units. Before lifting the grille frame into position, remove four (six on C2000R) M6 bolts fitted on the inside edge of air curtain.

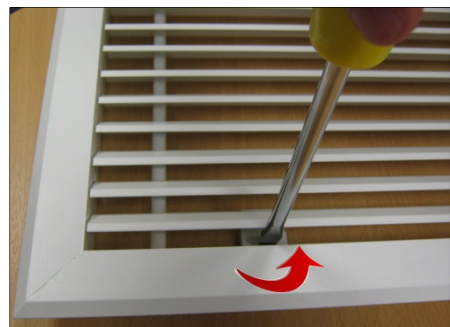

Fig 6

Step 2 Make sure the grille will go the correct way around (discharge nearest to doorway). Offer the recessed grille up through the cut-out in the ceiling.

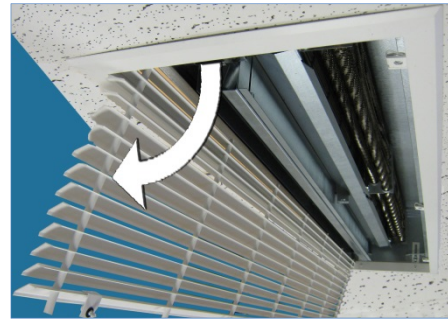

Fig 7

Step 3 Using the M6 bolts removed in Step 1, secure grille by fixing each bolt through the slotted brackets as shown in Fig 8. With the hinged grille open, adjust the height of the grille frame via slots in each bracket, so frame is snug fit against the ceiling with no gaps all the way around.

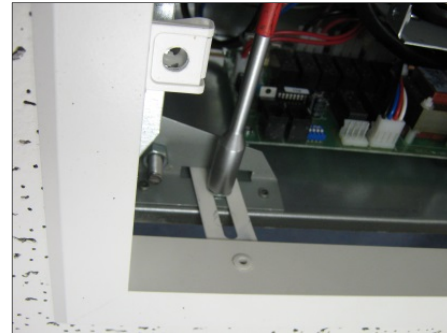

Fig 8

Step 4 To stop discharge air re-circulating within the air curtain a sliding separator will need adjusting up or down (see Fig 9). To adjust plate release M6 bolts either end, extend the slide plate so that it will touch the topside of the grille along its whole length and tighten the bolts. It will be necessary to close the hinged grille core to gauge where the separator plate should be fitted.



Fig 9

Step 5 Once the above steps are complete the hinged grille core can be closed and all the quarter turn fasteners tightened up.



Fig 10

NOTE: Open the hinged grille core to gain access to electrical connections, and for servicing and maintenance.

8. LPHW MODELS

For LPHW models ensure that water isolation valves are fitted in the flow and return pipework adjacent to the air curtain and connected correctly as shown in the diagram in Appendix 1.

For the design of the water pipework system and pump, water flow rates and pressure drops for maximum heat output of the air curtain are given in Table 2 below.

Table 2

Air Curtain	Water Flow Rate (l/min at 82/71°C)	Water Pressure Drop (kPa)
C1000WR, 1-row (6kW)	7.8	5.20
C1500WR, 1-row (9kW)	11.7	10.8
C2000WR, 1-row (12kW)	15.6	19.2

NOTE: Water Pressure Drop is across the flow and return pipework to the air curtain and includes for the coil fitted inside the unit and the valve fitted in the heating pipework to the unit. Water flow rates and pressure drops at different water temperatures can be calculated using the Thermoscreens coil calculation programme. Visit the Thermoscreens website for details.

The installer must connect the 3-port valve in the heating pipework as shown in Figure 11 below:

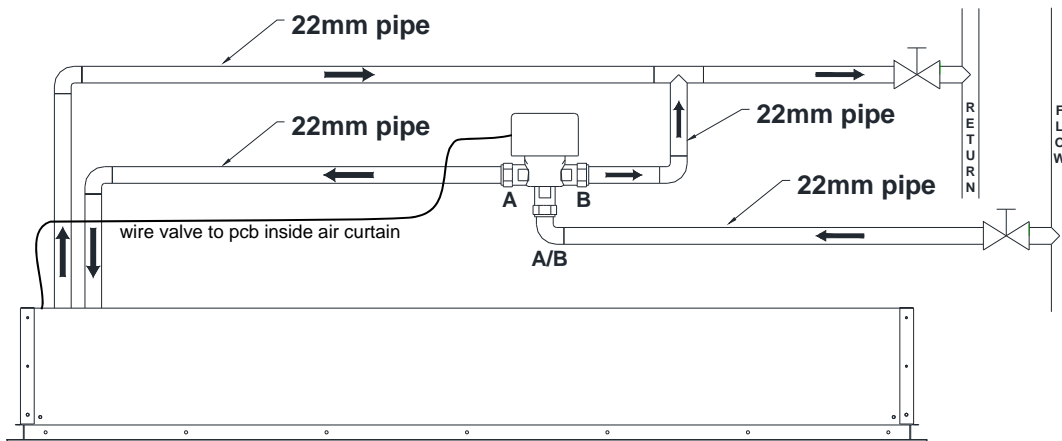

Fig 11

9. REMOTE CONTROL INSTALLATION

Mount the remote control unit in a convenient position directly to the wall or onto a switch box.

9.1 Wall mounting

Step 1 Using a screwdriver undo the screw on the top of the remote control case and pull the back case away (see Fig 12).

Step 2 Feed one end of the RJ control cable through the back case, secure it, then screw the back case to the wall using suitable fixings (not supplied).

Step 3 Connect the RJ plug to the RJ socket on the PCB in the remote control.

Step 4 Refit the front case.

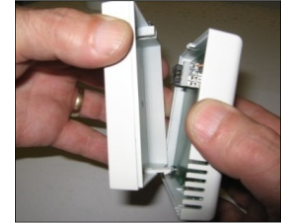

Fig 12

9.2 Switch box mounting

Step 1 Using a screwdriver undo the screw on the top of the remote control case and pull the back case away (see Fig 12).

Step 2 Feed one end of the RJ control cable through the switch box, feed and secure the RJ control cable through the back case and secure back case to switch box using 2 x M3.5 screws (not supplied) (see Fig 13).

Step 3 Connect the RJ plug to the RJ socket on the PCB in the remote control.

Step 4 Refit the front case.



Fig 13

NOTE: For optional remote control settings, see Section 10.

10. REMOTE CONTROL SETTINGS

On the back of the PCB inside the Ecopower Remote Control you will find four DIP switches that provide the following optional features, see Table 3.

Table 3

DIP	Feature	Explanation	Default	Notes
1	Reset on power-up	On restoring power after an electrical interruption all Remote Control settings are retained	ON	WARNING! – Fans start on their own after power is restored
2	Stop fan on cold	Fans are switched off when heating level is achieved (AUTO mode only)	OFF	
3	Never blow cold	Air curtain always heats in AUTO mode	OFF	Will not go to ambient mode
4	Room air temperature control	Enables the room air sensor in the Remote Control	OFF	Disables all other temperature sensors

11. EXTERNAL CONTROLS

11.1 Remote switch contacts IN0, IN1

Terminals IN0 and IN1 on the Ecopower PCB inside the air curtain can be used to provide different control strategies using remote volt-free contacts (see Fig 14). This could be to provide remote On/Off from a timer or BMS Digital/Output contact, to work with a door switch or for simple weather compensation control to disable heating when outdoor air temperatures become warmer. Table 4 describes the different functions:

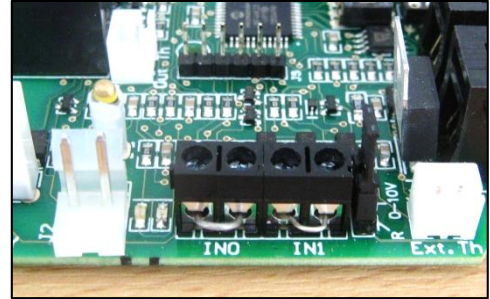









Fig 14

Table 4

Function	IN0		Notes
			
Remote On/Off (INHIBIT)	Unit operates normally in MANUAL Mode or AUTO Mode from the Remote Control	Unit switches off after 15s, with fan run-on at Medium fan speed if DIP 2 = OFF	Use the Remote Control to set up unit and then hide it away if required. * On/Off is then done via IN0 using a remote volt-free contact.

Function	IN1		DIP 4	IN0	Notes
					
Door Switch Control	After 30s the heating is disabled and the fan goes to low speed	Unit operates normally in MANUAL Mode or AUTO Mode from the Remote Control	ON		Door Open:-  Normal Control Door Closed:-  Heating Off Low Fan Speed
Summer Winter	Unit operates normally in MANUAL Mode or AUTO Mode from the Remote Control <i>COLD DAY</i>	Heating is disabled straight away, Fan speeds operate normally from the Remote Control <i>WARM DAY</i>	OFF		Simple weather compensation control using an outdoor air thermostat with volt free contacts (see Section 11.3)

NOTE: Wire volt-free, remote switch contacts to 2-way screw terminals IN0 and IN1 using 2-core cable.

WARNING: Do not apply any voltage to terminals IN0 and IN1 as this will damage the Ecopower PCB inside the air curtain.

* **NOTE:** The Ecopower Remote Control must stay plugged-in for the air curtain to keep working. An optional plug-in EEPROM is available from Thermoscreens so the Remote Control can be unplugged and the air curtain stay working. Visit the Thermoscreens website for details.

11.2 Overheat safety cut-out indication

For electric heated air curtains the Ecopower PCB includes a fault indication signal for if the overheat safety cut-out on the electric heater operates.

Volt free changeover contacts (6A 250VAC 30VDC) can be wired via the 3-way screw terminal “HEALTHY” (see Fig 15).

Refer to Section 18.1: Overheat safety cut-out, for how to reset a overheat safety cut-out situation.

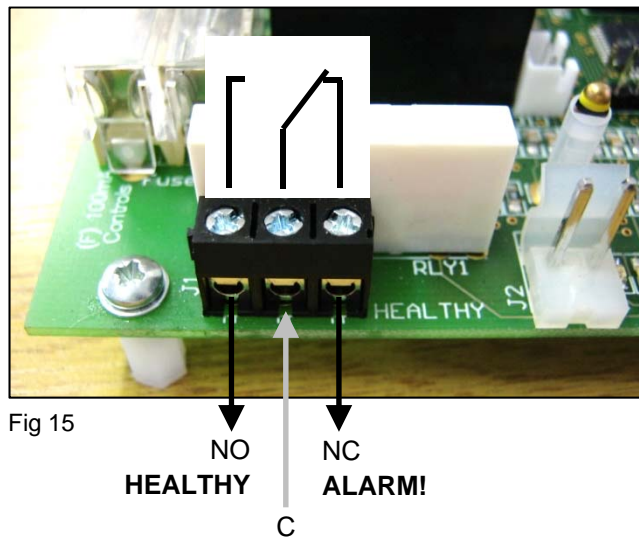

Fig 15

11.3 Weather compensation control (Summer/Winter)

To save heating energy on warmer days a simple weather compensation (Summer/Winter) heat control strategy can be used. Fit an outdoor air thermostat with volt-free contacts (supplied by the installer) to a north facing wall.

Use a 2-core cable to connect the outdoor air thermostat to 2-way terminal IN1 on the Ecopower PCB (see Fig 16)

On the Ecopower PCB, set DIP 4 to OFF as per Table 4, (see Section 11.1: Remote switch contacts IN0, IN1).

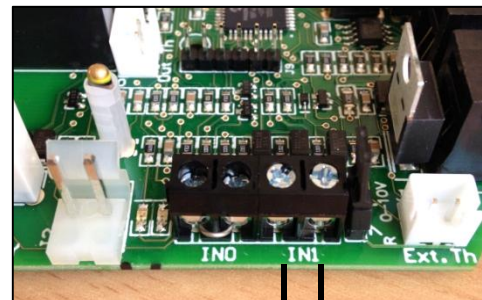

Fig 16

Switch Contact Closed = Heating Enabled (cold day)
Switch Contact Open = Heating Disabled (warm day)



WARNING: Do not apply any voltage to terminal IN1 as this will damage the Ecopower PCB.

NOTE: To promote increased energy saving a more advanced weather compensation control strategy is available from Thermoscreens. Using a heating curve, the discharge air temperature of the airstream coming from the air curtain is controlled against the outside air temperature. Visit the Thermoscreens website for details.

12. MULTIPLE AIR CURTAIN SYSTEMS

For master/slave control, plug and connect units together with Thermoscreen RJ extension cables (not supplied) as per Figure 17 below. Each air curtain must have its own electrical supply.

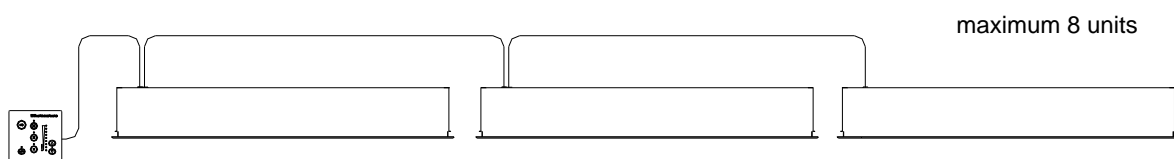

Fig 17

13. SYSTEM CONFIGURATION

13.1 Optional features

WARNING: Isolate and disconnect air curtain from the power source before making any changes.

DIP switches on the air curtain Ecopower PCB (see Fig 18) provide the following optional features, as explained below:

- Fan heat interlock
- Disable fan run-on
- Thermostat master (for master/slave installations)
- Weather compensation heat control (Summer/Winter)
- Door switch control



Fig 18

Feature	DIP setting	Default	Notes
<p>Fan heat interlock Allows fan speed to govern heat output on electric heated units.</p> <p>If low or medium fan speed is selected, a lower heat output results. High heat operates only on high fan speed.</p>	<p>DIP 1</p>	<p>ON</p> <p>Heat output is governed by fan speed.</p>	<p>This feature is only used with electric heated air curtains to limit very high air temperatures.</p> <p>Set DIP1 to OFF if unit is water heated or ambient.</p>
<p>Disable fan run-on The 2 minute fan run-on after switch off is enabled or disabled on electric heated air curtains.</p>	<p>DIP 2</p>	<p>OFF</p> <p>Fan run-on at medium speed enabled.</p>	<p>Must only be used for water heated or ambient air curtains. Each air curtain must have DIP2 set to ON for no fan run-on.</p>
<p>Thermostat master For master/slave installations. Only the air sensor in the thermostat master air curtain is used to measure air temperature.</p> <p>Set DIP 3 to ON in the air curtain that will be the master unit.</p>	<p>DIP 3</p>	<p>OFF</p> <p>Air curtains in master/slave systems all act independently.</p>	<p>Air sensor thermistors in all slave air curtains will be ignored.</p> <p>Stops some units blowing cold air and others blowing warm air in master/slave systems on larger doorways.</p>
<p>Weather compensation control or Door switch control</p> <p>Simple weather compensation control to save heating energy.</p> <p><u>or</u> Door switch control.</p>	<p>DIP 4</p>	<p>OFF</p> <p>IN1 Weather compensation.</p> <p>ON</p> <p>IN1 Door switch.</p>	<p>See Section 11.1 Remote Switch Contacts IN0 and IN1 for details</p> <p>Weather compensation control is the same as Summer/Winter control</p>

NOTE: ■ — Black rectangle is moveable head of DIP switch.

NOTE: A range of advanced factory fitted and plug-in control options are available from Thermoscreens to enhance the performance of the Ecopower PCB controller inside the air curtain. These include advanced weather compensation control using a heating curve, outlet air temperature control, ECObus® Modbus BMS control, modulating heater outputs and EEPROMs for non-standard control strategies. Visit the Thermoscreens website for details.

14. FAN SPEED SELECTION

Factory settings for the 3 fan speeds are shown in Table 5 below:

(refer also to wiring diagrams in Appendix 2)

Table 5

Fan Speed	Maximum air velocity at outlet grille (m/s)	Maximum air curtain mounting height (m)	Sound Pressure Level of air curtain [dB(A) at 3m]	Air Volume Flow Rate (m ³ /h) [for E & A]
HIGH (black wire)	8.5	2.75	C1000R - 55 C1500R - 55 C2000R - 56	1190 1730 2380
MEDIUM (blue wire)	6.5	–	C1000R - 53 C1500R - 53 C2000R - 54	1085 1580 2170
LOW (red wire)	5.0	–	C1000R - 50 C1500R - 49 C2000R - 50	975 1420 1950

Sound pressure levels dB(A) at 3m distance are for a single air curtain mounted at its maximum mounting height, operating in a room with average acoustic characteristics as defined in CIBSE Guide B5 (reverberation time 0.7s at 1kHz) and a room size equivalent to 8 air changes per hour (ac/h). Care needs to be taken when selecting air curtains for an installation as noise levels can be several dB higher if the mounting height is reduced, if the room is more 'live' (i.e. hard surfaces, no furnishings or absorbent materials), if the room is smaller than 8 ac/h equivalent or a combination of these factors. Noise levels will also increase if more than one air curtain is installed at the same doorway (e.g. +3dB(A) for 2 equal point sources: direct field).

15. REMOTE CONTROL OPERATION

15.1 Remote Control Switch (for Ambient units)

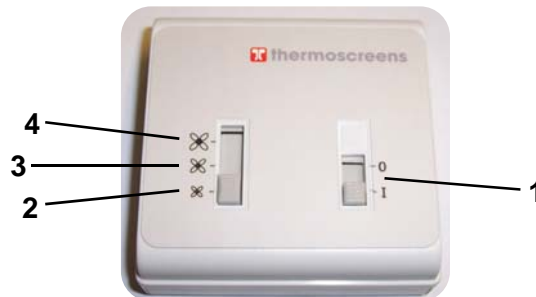

1 On/Off

Turns the air curtain fans On or Off.

2, 3 & 4 Fan speed

Switch fan speed between Low, Medium and High respectively.

15.2 Ecopower Remote Control (for Electric and Water Heated units)

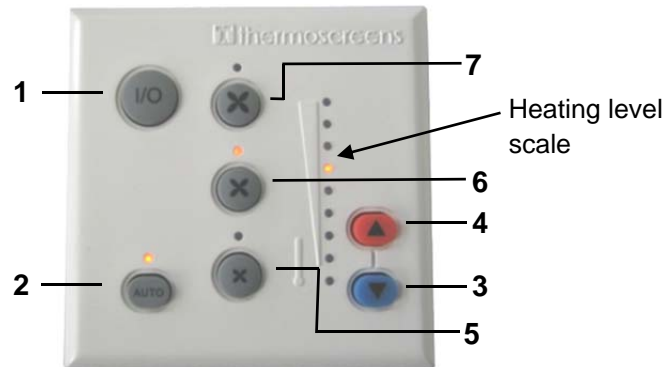

Use the remote control to operate the air curtain as follows:

1 On/Off

Turns the air curtain On or Off.

NOTE: If an electric heated air curtain is heating when switched off the fan will run-on for approximately 2 minutes to dissipate excess heat.

2 Manual/Automatic

Switches between Manual and Automatic modes.

The Auto On indicator LED is lit for "Auto Mode" and unlit for "Manual Mode".

3 & 4 Heating level controls

Manual mode

Select heating level from zero, to half heat, to full heat by stepping up or down with the heating level controls. The heating level scale shows the level selected.

Automatic mode

Heat output is controlled automatically according to:

- Inlet air temperature, or
- Room air temperature

This is dependent on the settings made in Section 10: Remote Control Settings (DIP switch 4).

5, 6 & 7 Fan speed

Switch fan speed between Low, Medium and High respectively. The appropriate LED illuminates.

16. COMMISSIONING THE SYSTEM

16.1 Verify system operation

To commission the system, verify the following conditions are met:

- All fans are working.
- Fans operate at Low, Medium and High speeds.
- There is no excessive mechanical noise coming from the fans.
- When heating is selected, the air stream from the discharge grille warms up across the whole length of the air curtain.
- When set to manual with fans set to high speed, heating increases as higher heat is selected.
- Warm air reaches across the doorway with door open or closed.
- Ecopower Remote Control operates correctly in both manual and auto modes.

16.2 Instruct operator and hand over

Before leaving site, hand over the installation to the end user or their representative.

Explain that any person operating the air curtain must be given supervision and instruction by the person responsible for their safety, concerning the safe use of the unit and to understand any hazards involved. Children and those with reduced physical, sensory or mental capabilities should not operate the air curtain.

Recommend that the doorway should be closed whenever possible but that during times of high pedestrian use it will become an 'open doorway'. The air curtain then serves an essential purpose by saving energy and providing comfort to occupants.

Explain that the inlet grilles and air filters (if fitted) must be cleaned regularly and the unit serviced at schedule intervals – see Section 19: Service & Maintenance.

NOTE: Leave these instructions with the customer/end user or their representative!!

17. SIGN OFF

Complete the following once commissioning is completed.

Installer signature		Customer signature	
Installer name		Customer name	
Installer company		Customer company	
Date		Date	

18. FAULT CONDITIONS

18.1 Overheat safety cut-out

An overheat fault in electric heated units may cause the overheat safety cut-out(s) to operate.

This is indicated by flashing LEDs on the remote control and a red status LED on the Ecopower PCB inside the air curtain.

Before resetting ensure there is adequate air flow from the air curtain and the unit has been commissioned as per Section 16.

To reset a overheat safety cut-out trip:

- Step 1** Switch off the electrical supply to the air curtain.
- Step 2** Allow time for the air curtain to cool down; typically 10 minutes.
- Step 3** Switch on the electrical supply to the air curtain.
- Step 4** Press the Auto button on the Ecopower remote control 4 times.

Air curtain heaters will then operate and after 30 seconds the LEDs on the remote control will stop flashing and the status LED on the Ecopower PCB in the air curtain will flash green.

18.2 Fuses

In the event of an electrical fault internal electrical fuses may operate.

There are two internal fuses located on the Ecopower PCB inside the air curtain:

- Fuse 6.3A (T) supplies the fan motors within the air curtain
- Fuse 100mA (F) controls the operation of the motherboard

18.3 Ecopower PCB status indication

There is a status LED on the Ecopower PCB inside the air curtain (See LED shown on Wiring Diagrams in the Appendix).

This indicates the status of the Ecopower Control system as follows:

1. LED flashing green – operation normal
2. LED flashing red – low supply voltage, remote control not plugged in or RJ cable fault
3. LED permanently red – overheat safety cut-out(s) open circuit from an overheat situation (see Section 18, Fault Conditions for how to reset)

19. SERVICE & MAINTENANCE

WARNING: Failure to adequately maintain the unit and provide a suitable cleaning schedule will result in a loss of performance and reduced life expectancy of the air-curtain and possible overheating and fire risk with electric heated units.

19.1 Every week

NOTE: Weekly maintenance can be carried out by the Cleaner or Janitor from floor level.

Turn off the air curtain to prevent dust entry, then clean the face of the recessed grille using a vacuum cleaner with an extension tube and brush.

19.2 Every 3 months

WARNING: Before servicing, isolate and disconnect the air curtain from the electrical power.

WARNING: The following servicing and maintenance must be carried out by a competent electrician or a Thermoscreens appointed technician.

Clean and inspect the inside of the air curtain as follows:

- Step 1** Open the hinged inlet grille using a flat bladed screwdriver to release the quarter turn fasteners (see Fig 6, Section 7.3).
- Step 2** Clean and remove any build-up of dust and dirt within the air-curtain (inlet/outlet grilles, electric heaters, fan impellers, housings and motors) using a vacuum cleaner and soft brush.

NOTE: Build-up of dirt on fan impellers can cause vibration, noise and excessive wear on the motor bearings.

- Step 3** Check within the unit to ensure all electrical connections and crimped terminals are tight and that all cables are in good condition.

Close and secure hinged inlet grille after servicing. Reconnect electrical supply and test to ensure correct operation (see Section 16: Commissioning).

20. WARRANTY

All units are covered by a two year warranty.

Failure to adequately maintain the unit may void the warranty. If any problems are encountered, please contact your installer/supplier.

If any problems are encountered, please contact your installer/supplier.

Failing this please contact the Thermoscreens warranty department.

Care has been taken in compiling these instructions to ensure they are correct. Thermoscreens Ltd. disclaims all liability for damage resulting from any inaccuracies and/or deficiencies in this documentation. Thermoscreens Ltd. retain the right to change the specifications stated in these instructions.

Thermoscreens Ltd
St. Mary's Road Nuneaton
Warwickshire England
CV11 5AU

Email: sales@thermoscreens.com
Tel: + 44 (0) 24 7638 4646
Fax: + 44 (0) 24 7638 8578
www.thermoscreens.com

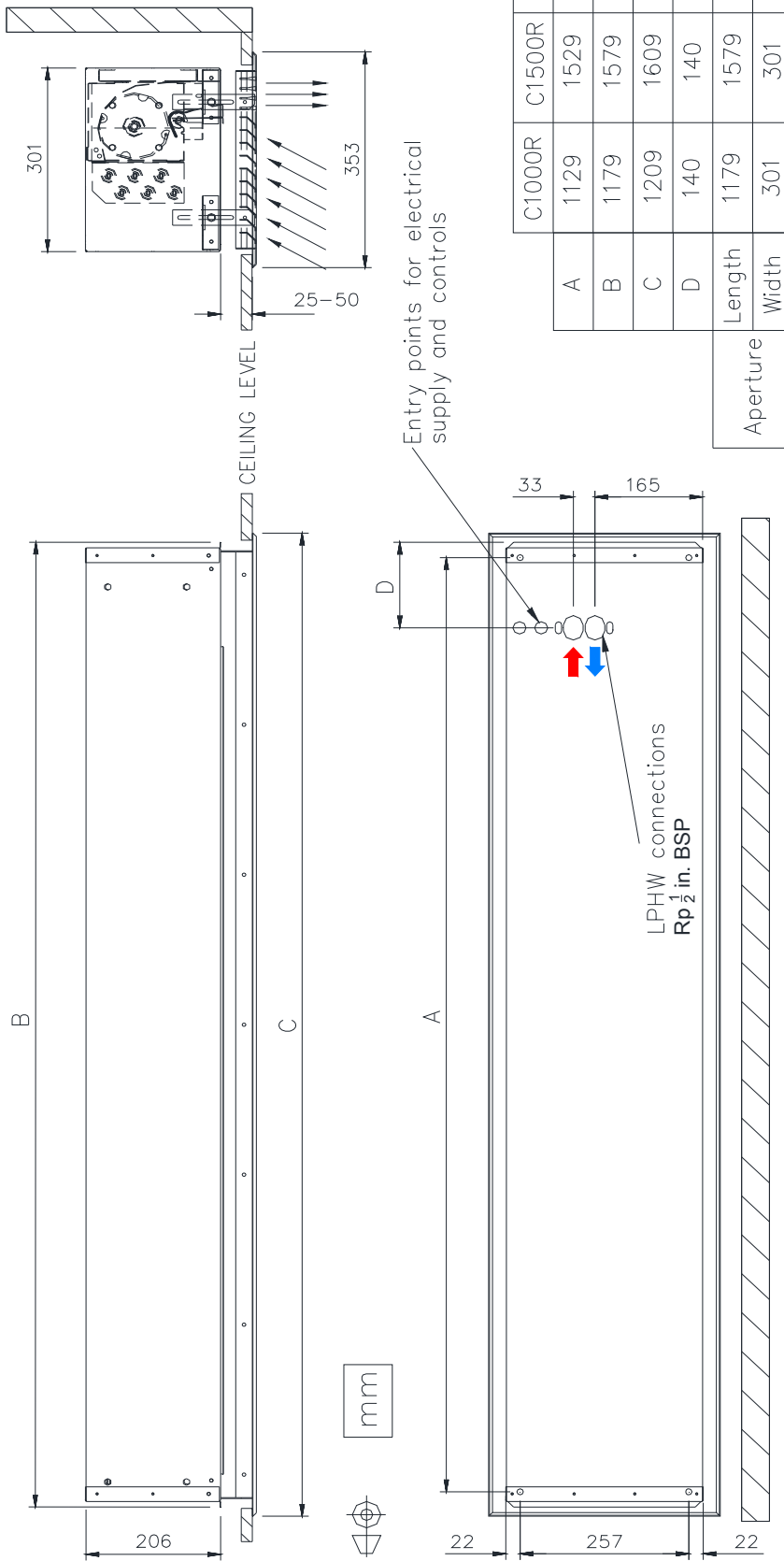

	C1000R	C1500R	C2000R
A	1129	1529	2040
B	1179	1579	2090
C	1209	1609	2120
D	140	140	150
Length	1179	1579	2090
Width	301	301	301
Aperture			

APPENDIX 1 — DIMENSIONS OF C RECESSED AIR CURTAIN

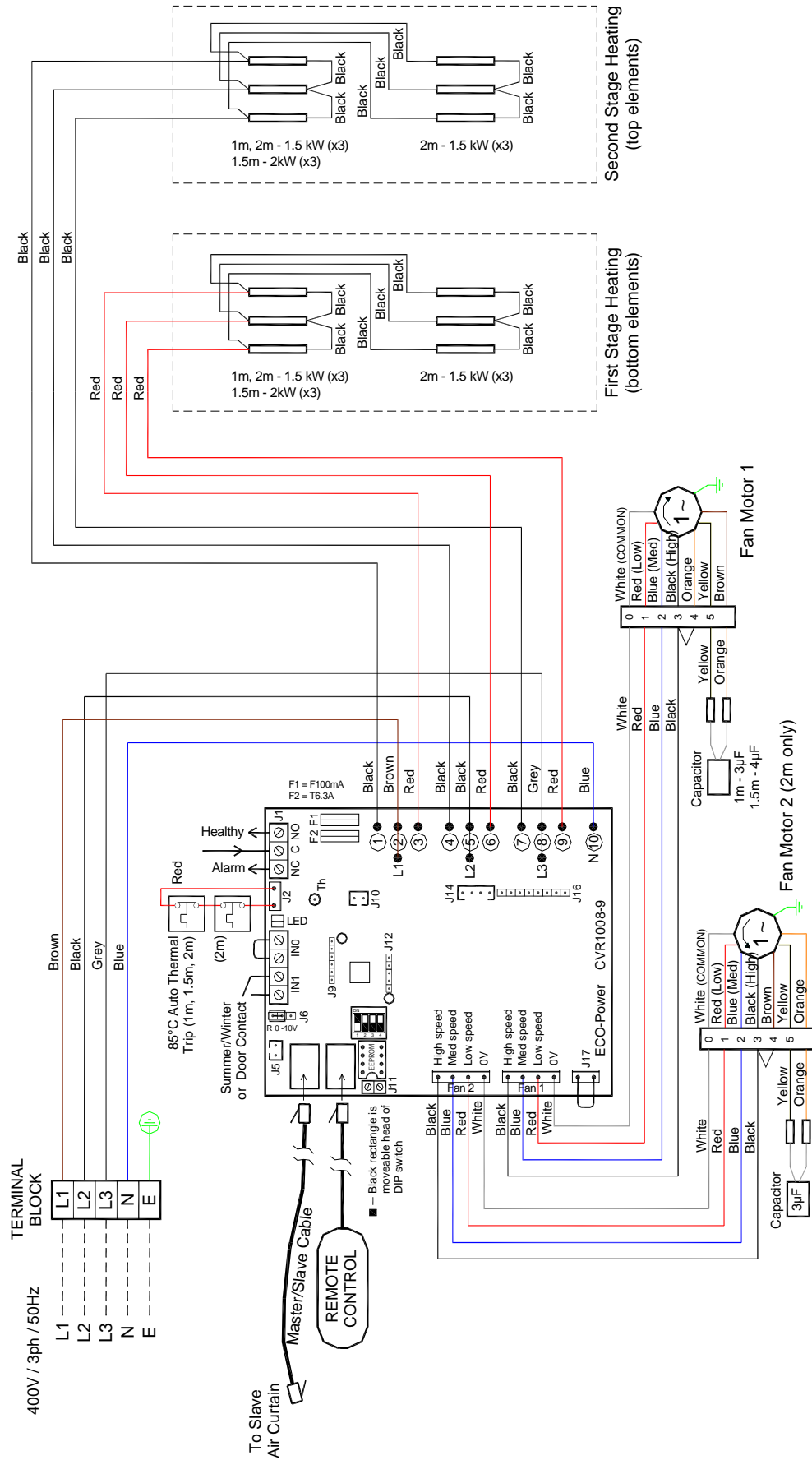

APPENDIX 2A — WIRING DIAGRAM C1000E, C1500E and C2000E

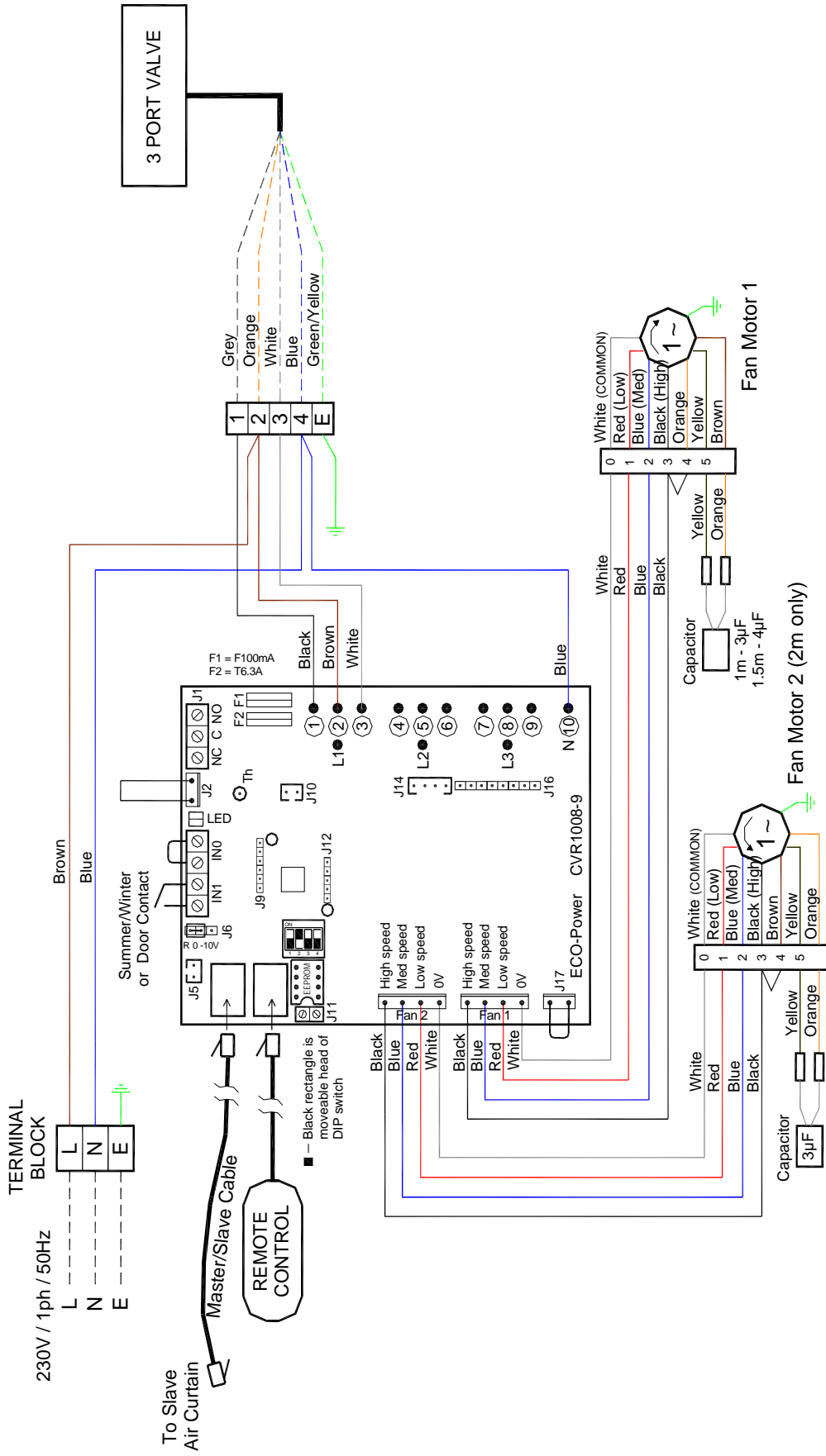

APPENDIX 2B — WIRING DIAGRAM C1000W, C1500W and C2000W

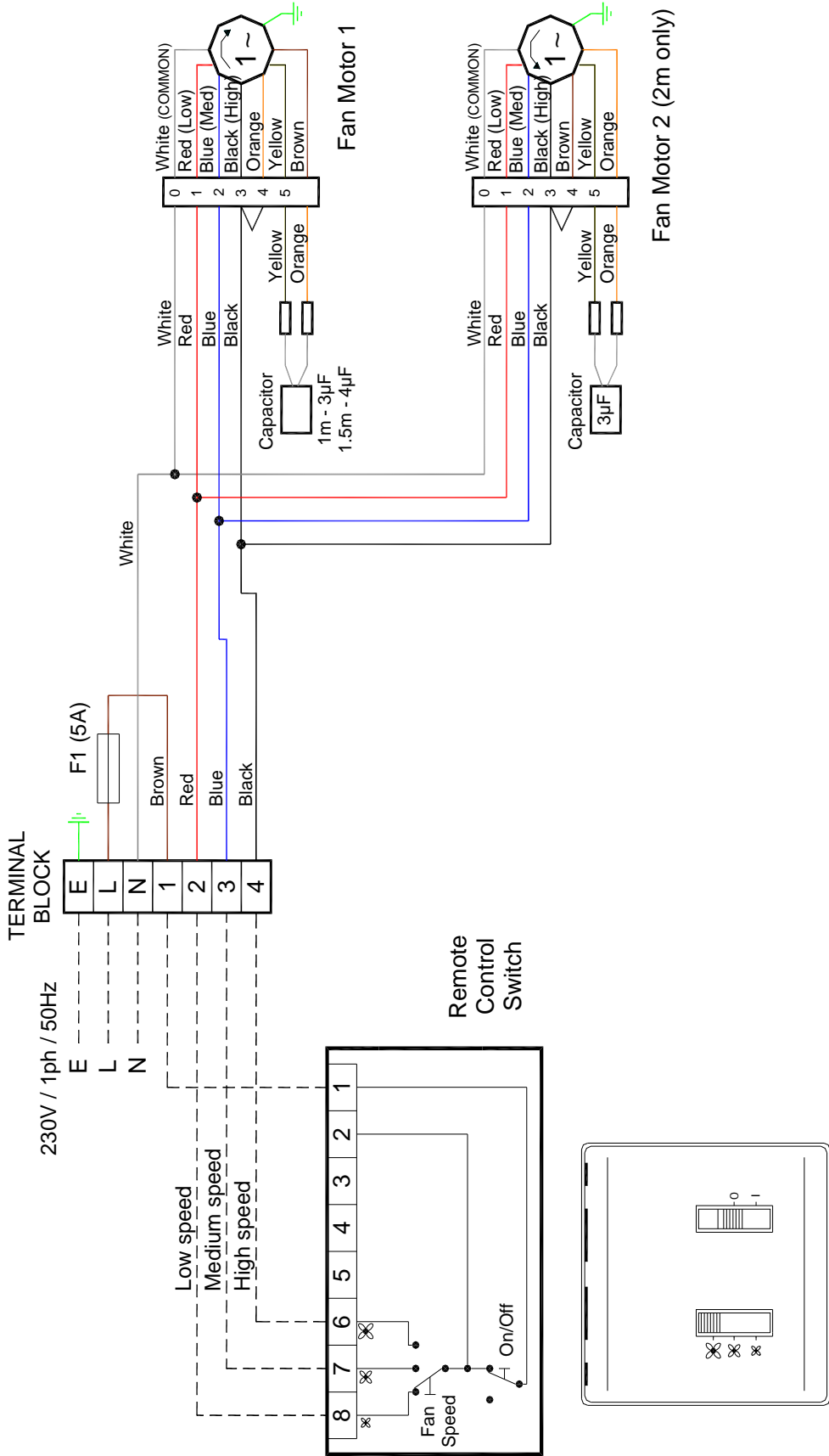

APPENDIX 2C — WIRING DIAGRAM C1000A, C1500A and C2000A

20. DECLARATION OF CONFORMITY

Thermoscreens Ltd
St. Mary's Road
Nuneaton
Warwickshire
CV11 5AU
United Kingdom
Telephone: +44 (0)24 7638 4646
Fax: +44 (0)24 7638 8578



EC DECLARATION OF CONFORMITY
as defined by the EC Council Directive on Machinery 2006/42/EC,
the Low Voltage Directive 2006/95/EC, Electromagnetic Compatibility Directive 2004/108/EC,
the Energy related Products Directive 2009/125/EC

Herewith we declare that the air movement equipment designated below, on the basis of its design and construction in the form brought onto the market by us in accordance with the relevant safety, health and performance requirements of the Machinery.
If alterations are made to the machinery without prior consultations with us, this declaration becomes invalid.

Designation of Equipment: AIR CURTAINS

Series Type: C1000A; C1000E; C1000W; C1500A; C1500E; C1500W;
C2000A; C2000E; C2000W
(in Casing Styles: Surface Mount and Recessed)

Relevant EC Council Directives: the Machinery Directive (2006/42/EC)
the Low Voltage Directive (2006/95/EC)
the Electromagnetic Compatibility Directive (2004/108/EC)
the Energy related Products Directive (2009/125/EC)

Applied Harmonised Standards: Machinery - EN ISO 14121-1:2007, EN 294:1992, EN 414:2000
LVD - EN 60335-1:2012, EN 60335-2-30:2009+A11:2012
EMC - EN 61000-6-1:2007, EN 61000-6-3:2007+A1:2011,
EN 61000-3-2:2006+A2:2009, EN 61000-3-3:2008
ErP - Commission Regulation (EU) No.327/2011,
ISO 5801:2007, ISO 12759:2010

Basis of Self Attestation: Quality Assurance to BS EN ISO 9001: 2008
B.S.I. Registered Firm Certificate Number FM 85224
SGS Test Report ELS150049/2/R/DC/11;
SGS Test Report EMC150049/1
CE Marking Association Test Report 6799 and 6800

Responsible Person: Mr. P. Casey, Operations Director, Thermoscreens Ltd.

Date: 20 March 2014

Signed: 